

Design considerations of a linear generator for a range extender application

UN-JAE SEO, BJÖRN RIEMER, RÜDIGER APPUNN, KAY HAMEYER

*Institute of Electrical Machines, RWTH Aachen University
Schinkelstr. 4, 52062, Aachen, Germany
e-mail: UnJae.Seo@iem.rwth-aachen.de*

(Received: 10.09.2015, revised: 20.09.2015)

Abstract: The free piston linear generator is a new range extender concept for the application in a full electric vehicle. The free piston engine driven linear generators can achieve high efficiency at part and full load which is suitable for the range extender application. This paper presents requirements for designing a linear generator deduced from a basic analysis of a free piston linear generator.

Key words: linear generator, free piston engine, range extender electric vehicle

1. Introduction

A range extender (REX) is an auxiliary power source of an electric vehicle (EV) to increase travel-distance. A free piston linear generator (FPLG), shown in Fig. 1, is a potential efficient power source for the range extender application. There is no crankshaft mechanism which facilitates variable stroke length and a piston can be controlled on each stroke by appropriate fuel injection timing. Unlike conventional engines that the piston motion is determined by the crank system, the piston motion of free piston engine is determined by the instantaneous force balance on the mover, which the piston motion may vary for different operating conditions. Numerous linear generators for integration in the free piston engine have been analyzed [1-5].

An engine of a series hybrid electric vehicle does not deliver mechanical energy to the wheel but electrically converted energy by a generator is delivered to the electric motor. Hence, the operating points of the engine is not governed by demands of a driver and it can be operated at its efficient speeds and loads. Such operating points are influenced by the stage between the injected fuels and DC output power, such as the engine, generator, power electronics and power management controller of the vehicle. Each different configurations of stage may demand different design requirements to the generator.

The reciprocating movement of a linear generator produces pulsating power, varying voltage and frequency. The velocity of the movement is not sinusoidal and the average velocity of each half period is differed due to different applied forces during combustion and expansion process. The analysis of the linear generator ran by the free piston engine should consider the

behavior of the prime mover of the generator. The output power of the generator has to be buffed to compensate the pulsating power. A high capacitive energy storage device is necessary to deliver constant power. The configuration of such power conditioner gives additional design requirements to the linear generator such as allowable induced voltage.

In range extender electric vehicle, the power management controller determines the output power of the REX since the delivered power to the electric motor is the combined power of the REX and the battery. Therefore, the vehicle simulation with power management controller is necessary to verify the operating conditions of the REX, hence, the generator.

As presented in [21], this paper conducts system level simulation in order to facilitate the design of the linear generator. This allows the design at a system level, considering the vehicle.

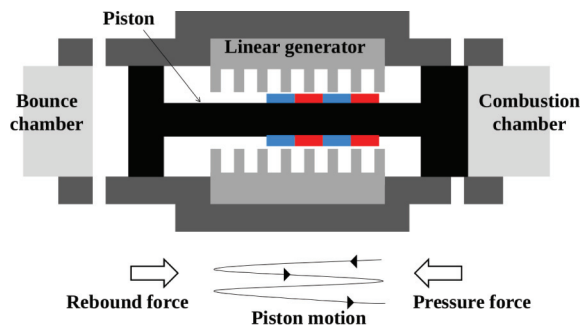

Fig. 1. Schematic of a free piston linear generator

2. Simulation of range extender vehicles

A series hybrid electric vehicle is the simplest configuration of hybrid electric vehicles. The electric motor is the only mean to provide the power to the vehicle's wheel which is demanded by the driver. The power delivered to the electric motor is combined power of the range extender and the battery. The efficiency map of the free piston linear generator is not available at the stage of design. Therefore, the requirements of the range extender electric vehicle (REX-EV) with a free piston linear generator are delivered by analytical calculations. First, one reference battery electric vehicle (BEV) is selected and compared the analytical stored energy, which can be delivered to the electric motor. The assumption is made that the energy differences between the REX-EV and BEV is proportional to the difference of travel-distance. The required battery capacity, fuel tank of the REX-EV to travel K times more distance than the BEV in same mass condition is revealed by the analytical mean enhanced by the results of vehicle's power management simulation.

2.1. Delivered energy to the electric motor

There are two driving modes in a REX-EV, charge depleting (CD) mode which deplete the battery energy driving pure electrically and charge sustaining (CS) mode which sustain the

state of charge (SOC) of the battery at reference level by the REX. The energy delivered to the electric motor in CD mode is

$$E_{cd} = n_{dis} (n_{ch} E_d^- + E_b), \quad (1)$$

where E_d^- , E_b , n_{dis} , n_{ch} is negative demand energy from the electric motor due to braking, battery energy, discharging and charging efficiency of the battery respectively. The energy delivered to the electric motor in CS mode is followed by,

$$E_{cs} = n_{dis} n_{ch} E_d^- + \alpha \hat{n}_{rex} E_f, \quad (2)$$

where α is a controller coefficient, which will be discussed in a later section, and \hat{n}_{rex} is the peak efficiency of REX and E_f is fuel energy. Only CD mode can be applied in case of the BEV. By assuming that REX-EV can deliver K times more energy than demand energy, the energy ratio of REX-EV and BEV for two modes are

$$K_b = \frac{E_b}{E_B}, \quad K_f = \frac{\alpha \hat{n}_{rex} E_f}{n_{dis} E_B}, \quad (3)$$

where E_B is the battery energy of the BEV. The discharging and charging efficiency is assumed as same for both vehicles and operating modes. The energy can be represented using energy density coefficient and mass as follow.

$$K_b = \frac{m_b}{m_B}, \quad K_f = \frac{\alpha \hat{n}_{rex} a_f m_f}{n_{dis} a_b m_B}, \quad (4)$$

where m_b is mass of the battery of REX-EV, m_B is those of BEV, m_f is fuel mass, a_f is fuel energy density, which is 12.5 kWh/kg in case of diesel and a_b is battery energy density, 0.11 kWh/kg. The energy ratio between BEV and REX-EV is summation of (4) that is same to the travel distance ratio. The mass condition for BEV and REX-EV is,

$$m_B = m_f + m_b + m_{rex} + m_{sys}, \quad (5)$$

where m_{sys} is mass of the fuel tank system which is set to 25 kg.

2.2. Required maximum power of range extenders

The demanded power of electric motor becomes high when a vehicle climbs up a hill. In this case, both battery and REX deliver power to the electric motor, depleting the battery energy continuously. Once the SOC of battery reaches its low boundary, discharging the battery becomes restricted, hence the velocity of vehicle becomes reduced as only range extender cannot fulfill the demanded power. As higher maximum power of the range extender and larger battery capacity, longer distance for climbing up a hill is possible before the output of the battery is restricted. The required force to climb up a hill with constant speed is,

$$F = fmg + c_d v^2 + mg \sin(\theta), \quad (6)$$

The range extender has to deliver its maximum output power to the electric motor.

$$P_{\text{rex,max}} + \frac{P_{\text{battery}}}{n_{\text{dis}}} = \frac{Fv}{n_{\text{motor}}} + P_{\text{auxiliary}} \tag{7}$$

We have calculated the maximum output power of range extender by following manner.

$$P_{\text{rex,max}} = \frac{Fv}{n_{\text{motor}}} + P_{\text{auxiliary}} - \frac{n_{\text{dis}} 3600 E_b \Delta SOC}{t_d}, \tag{8}$$

where $E_b \Delta SOC$ is the available kWh battery energy and t_d is the travel time before the SOC reach minimum boundary. The travel time is equal to the travel distance divided by the velocity, which is restricted to

$$P_{\text{battery}} t_d \leq 3600 E_b \Delta SOC. \tag{9}$$

2.3. Vehicle simulation with power management control

The algorithm employed in this paper is a stochastic model predictive control (SMPC) referring to [6], as the exact knowledge of a range extender efficiency map is not necessary in the MPC. The SMPC problem formulation is minimizing the cost function as,

$$\min_{\Delta P_i} \sum_{i \in T \setminus \{T_f\}} \pi_i (x_i - x_{\text{ref}}) \begin{bmatrix} Q_{\text{soc}} & 0 \\ 0 & Q_f \end{bmatrix} (x_i - x_{\text{ref}}) + \sum_{j \in T \setminus s} \pi_j Q_p \Delta P_j^2, \tag{10}$$

where the state x is the battery SOC and the output power of REX. x_{ref} is reference of the state. The reference of the REX output power is its highest efficiency point of the REX. Q_{soc} , Q_f , Q_p is scalar weight and ΔP is the output power variation of the REX from a previous node. π is the probability to reach a node from the current step, which is defined by the Markov chain on the given driving cycles. The problem can be solved via quadratic programming at every time steps. The details of the formulation can be found in [7].

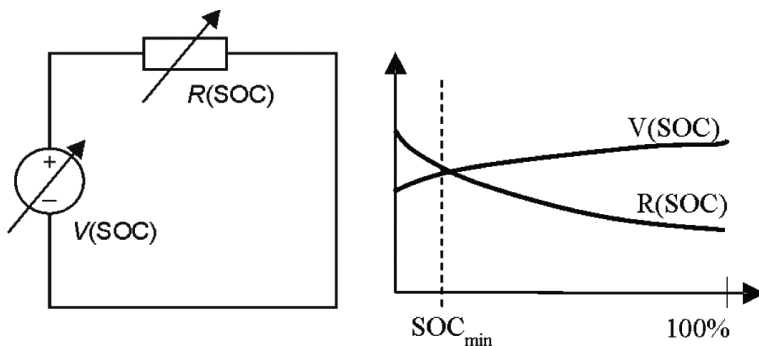

Fig. 2. Battery equivalent circuit

Table 1. BEV simulation parameters

Quantity	Value
Mass	1480 kg
Drag coefficient	0.35
Rolling coefficient	0.015
Electric motor peak power	80 kW
Battery capacity (usable)	21 kWh

We used Rint model neglecting temperature effects to represent a battery as shown in Fig. 2. The electric circuit in the Rint model consists of a voltage source and a charging or discharging resistance which are function of state of charge (SOC):

$$P_b = V_o I_b - I_b^2 R_b. \tag{11}$$

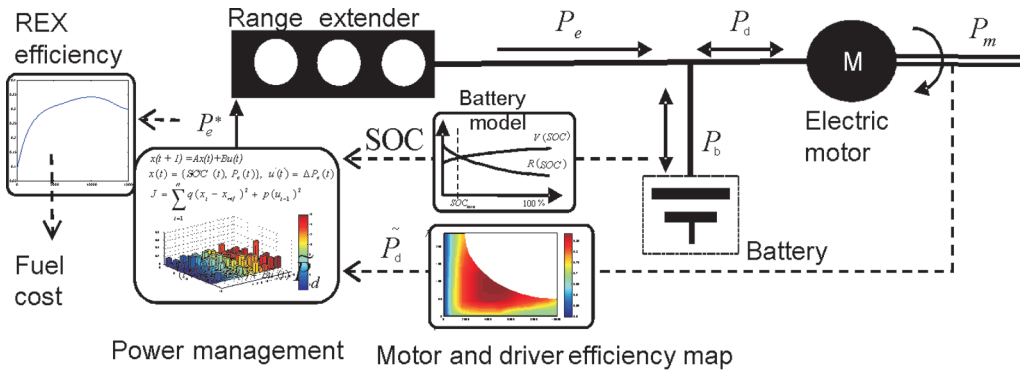

Fig. 3. Schematic of a free piston linear generator

Table 2. Artemis driving cycle simulation results

Operating mode	Criteria	Driving cycle		
		Urban	Rural	Motor way
CD	Battery energy consumption [kWh/km]	0.15	0.16	0.24
	Average discharging/charging efficiency [%]	95/96	93/95	88/94
CS	Average REX efficiency [%]	31	33	32
	Average discharging/charging efficiency [%]	95/94	93/93	93/92

$$I_b = \frac{V_{oc} \pm \sqrt{V_{oc}^2 - 4I_b R_b}}{2R_b}, \tag{12}$$

$$V_{oc} = V(SOC), \quad (13)$$

$$R_b = R_{dis}(SOC) \text{ or } R_b = R_{ch}(SOC). \quad (14)$$

The variation of SOC per second due to consumed energy can be calculated as follow.

$$\Delta SOC = \frac{-I_b}{Ah \cdot 3600}, \quad (15)$$

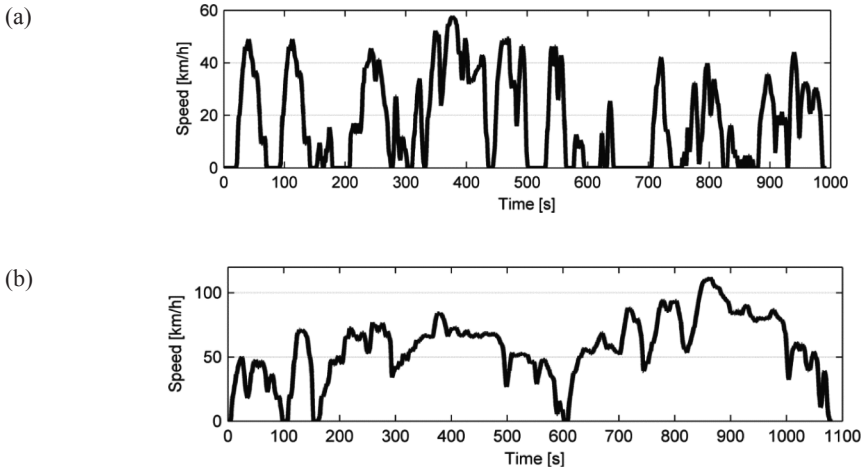

Fig. 4. Speed profile of Artemis driving cycle. (a) rural (b) urban

where Ah is the capacity of a fully charged battery in ampere hours and positive battery current is the discharge current of the battery. The simulation structure is shown in Figure 3. The efficiency map of the electric motor was obtained from the finite element analysis and its driver efficiency is assumed to be 97% constant efficiency. The delivered power to the electric motor in a REX-EV is the combined power of a battery and a REX. The CS and CD mode simulation on Artemis driving cycles [8] was performed with the vehicle parameters presented in Table 1. The urban and rural Artemis driving cycles are shown in Figure 4. The Artemis cycles are chassis dynamometerbased on statistical analysis of a large database of European real world driving patterns. Since a real free piston engine for measurement is not available, we refer [9] for different engine efficiency curves as shown in Figure 5.

Table 3. Controller coefficient on Artemis driving cycle

Reference power	Urban	Rural	Motorway
15 kW	0.9	0.93	0.92
20 kW	0.89	0.92	0.96
30 kW	0.86	0.89	0.95

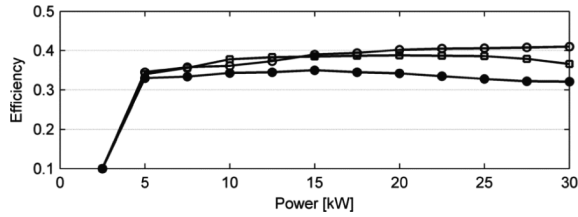

Fig. 5. Conventional vehicle engine efficiency curves

The maximum output power was scaled as half, which is originally 60 kW. The REX-EV with the three engines were simulated on the driving cycles. The obtained results of the engine on the motorway cycle, which has 34% peak efficiency at 15 kW, is shown in Figure 6.

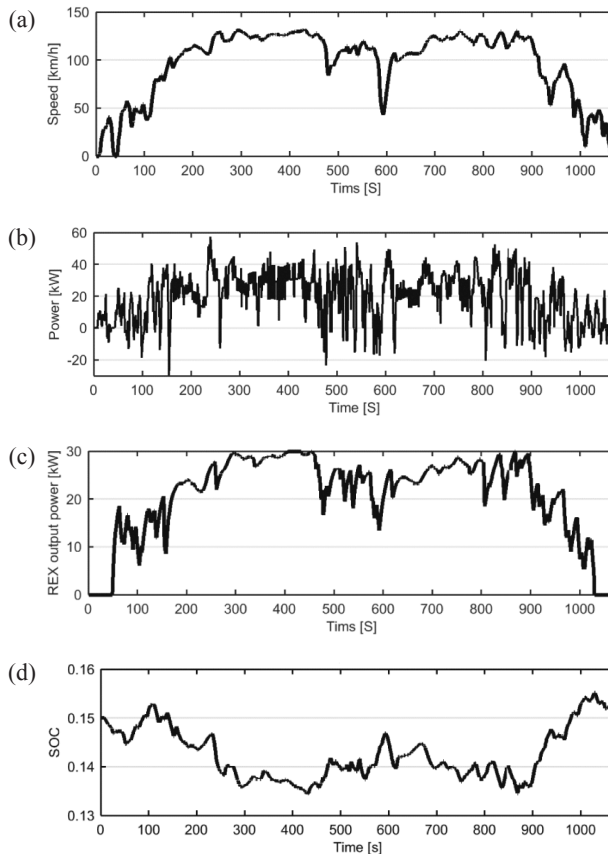

Fig. 6. Artemis motorway cycle simulation. (a) speed profile, (b) demanded power, (c) output power of the range extender, (d) SOC of the battery

The motorway cycle is challenging due to high accelerations and speeds. The SOC cannot be maintained at the reference SOC (15%) due to high demand power. However, the SOC is not reached at the given low boundary (10%) where the performance of the vehicle becomes limited

as discussed in the section 2.2. The energy efficiency of those results are presented in Table. 2 for both CD and CS modes. In case of the engine having its peak efficiency at 15 kW, it shows the highest average efficiency on the rural driving cycles.

The simulation results of all three efficiency curves were applied to estimate the controller coefficient in (4). Each reference operating point of the SMPC was differed by each REX efficiency curves. The calculated results are presented in Table 3. As the efficiency curve of the free piston linear generator is not available, the obtained parameter is used to define the parameters of the REX-EV with a free piston linear generator.

2.4. Requirements of REX vehicles with a free piston linear generator

The requirements of the REX-EV with the free piston linear generator to travel 2.5 times more distance than the reference BEV have been analyzed, which means the combined of (4) is 2.5. The specifications of the free piston linear generator are 34% peak efficiency and 0.34 kW/kg power density [10]. The battery efficiency and controller coefficient is assumed as 93% and 0.91 respectively to solve (4). The required power of the REX is calculated by (8) with conditions that 5 km distance, 100 km/h velocity, 3% available battery energy and 3% grade hill. The driving distance of reference BEV was assumed as 109 km (0.17 kWh/km) and REX-EV has to travel 2.5 times more distance. The obtained specifications of the REX-EV with the free piston linear generator is shown in Table. 4.

3. Modeling and simulation of a free piston engine

In order to find the design specifications of the linear generator, the single zone and zero dimensional model is used for the free piston engine simulation. The piston motion is not mechanically prescribed but is rather a result of the balanced in-cylinder pressures, inertia forces, friction forces and the applied load. A dynamic model of the piston motion from Newton's 2nd law can be represented as

Table 4. Requirements of the REX-EV with FPLG

Quantity	Value
Curb weight	1400 kg
Battery capacity	11 kWh
Fuel tank	12 L
REX maximum power	28 kW
Driving distance	270 km

$$m \frac{d^2x}{dt^2} = F_L + F_R - F_e, \quad (16)$$

where $F_L + F_R - F_e$, is force from each cylinder and electromagnetic force of the linear generator respectively. The following equation is used to calculate the in-cylinder pressure at each time step [11] :

$$\frac{dp}{dt} = \frac{\gamma - 1}{\gamma} \frac{dQ}{dt} - \gamma \frac{p}{V} \frac{dV}{dt}, \quad (17)$$

where p , V , γ , Q is the instantaneous cylinder pressure, volume, ratio of specific heat and added energy during the combustion process.

In combustion model, a time based Wiebe function is used to express the mass fraction burned in the combustion process as follow.

$$\chi(t) = 1 - \exp\left[-a \left(\frac{t - t_0}{t_c}\right)^{1+b}\right]. \quad (18)$$

The control objective of a free piston engine is maintaining the top dead center (TDC) and bottom dead center (BDC) at desired position. We referred Milkalsen and Roskillys investigation [8]. The control inputs are fuel mass, air mass in bounce chamber and electric load force while output are TDC and BDC position. The simulation results are shown in Figure 7 which is far from sinusoidal. The obtained speed profile can be used for numerical analysis of the linear generator.

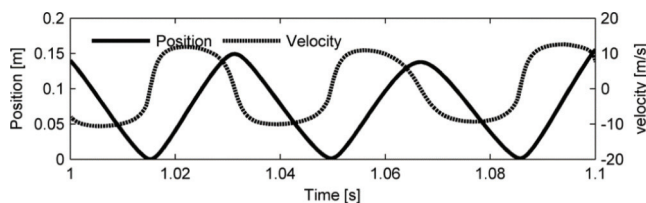

Fig. 7. Simulation results of the free piston engine

4. Output power conditions of a free piston linear generator

The mechanical frequency of the free piston engine is lies usually in the range of 30 Hz [13-18]. By assuming that the power delivered to the electric motor side is constant, the pulsating term goes to the DC link and it has to be absorbed by the capacitor. Due to low frequency, it demands high capacitance for the DC link capacitor of the linear generator to suppress the voltage ripple of the capacitor. The capacitor voltage ripple for the given capacitance can be calculated by assuming the sinusoidal velocity of the mover and applied generator force [17].

$$C = \frac{2P_0}{\omega \Delta V \sqrt{4\bar{V}_c^2 - \Delta V^2}}, \quad (19)$$

where P_0 , ω , C , \bar{V}_c , ΔV is the average power, angular mechanical frequency of the mover, capacitance, average voltage of the capacitor and peak to peak capacitor voltage respectively. For 30kW average output power (60 kW peak), 10% voltage ripple, 30 Hz, and 500 V_{dc} average DC link voltage, the required capacitance is 6.4mF. The mechanical frequency of the piston should be increased further up to 50 Hz as indicated in [10] for their next prototype of the free piston engine. The possible power electronic configurations are the bi-directional converter in series

with the generator inverter or the super capacitor in parallel with the generator inverter to absorb the pulsating power as shown in Figure 8.

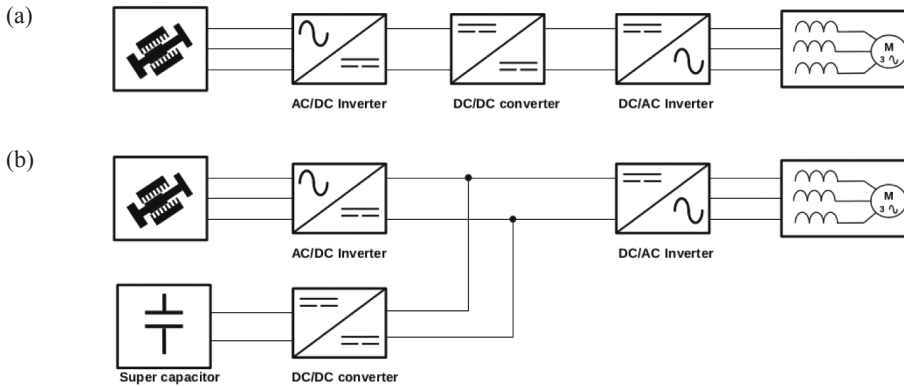

Fig. 8. Power electronic configurations converter for power conditioning. (a) Series connected, (b) Parallel connected converter.

With series connected converter, the converter can control the average DC link voltage of the generator inverter. However, the capacitance should be high to avoid excessive voltage ripple. The simulation results of series connected converter with the inverter fed linear generator ran by the free piston engine is shown in Figure 9.

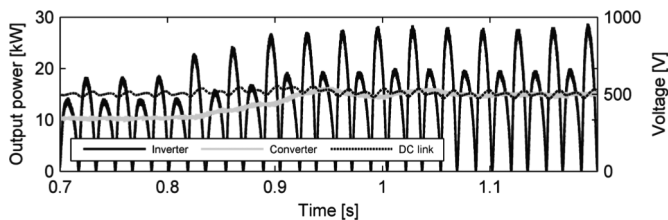

Fig. 9. Simulation results of the series connected converter

The output power command is changed to 15 kW from 10 kW during the simulation. For parallel connected converter, the super capacitor can absorb the pulsating energy from both battery and the linear generator by controlling the common DC link voltage of the battery converter, motor and generator inverters. Moreover, the energy of super capacitor can be delivered to the electric motor instead of the battery for a short moment when the load is suddenly changed, such as the sudden acceleration or de-acceleration of the vehicle [20].

5. Design consideration of a linear generator

The velocity of the translator mounted on the piston is directly dependent upon the moving mass, which is one of the most important parameter in this system. The system should be

installed beneath the driver's seat as discussed in [10] to secure sufficient length for the opposed piston FPLG topology. Hence, the generator would be thin and long. Tubular type linear generators are not suitable for this application due to the space limitation.

The longitudinal stator topology have an advantage of the reduced moving mass while it suffers from increased system mass due to long stator. The possible solution to decrease the mass of longitudinal mover is the ironless mover with Halbach array permanent magnets. The leakage flux of the Halbach array magnetized permanent without mover back iron is relatively weak due to the virtually self-shielding property [1].

In series HEV, the REX operates only at its most efficient speeds and loads as it is not coupled to the wheels. Thus, the operating points to analyze the linear generator is limited by operating points of its prime mover. It can significantly reduce the necessary analysis points as fundamental of the free piston engine was analyzed. Unlike the electric motor of the EV, the output of linear generator is governed by the power management algorithm while the output of electric motor directly follows the demand power of driving cycle. As the output power profile of the REX has been obtained, the performance index can be established for the linear generator design process.

6. Conclusion

The numerical simulation and design of the linear generator employed as range extender has been performed. The reference BEV was chosen and the REX-EV with the FPLG to drive 2.5 times more distance than reference BEV in same mass condition have been analyzed. The REX-EV with the FPLG requires 12 L fuel tank, 11 kWh battery to travel desired distance. The output power of the REX has been calculated by the desired climbing-distance, 5 km, when a vehicle climbs up a hill with 100 km/h velocity, 3% grade and 3% of available battery energy. The free piston engine has been simulated to find the design specifications of linear generator. The mass of mover is the most important parameter of the linear generator since it determined the velocity of the piston. The power conditioning stage of the FPLG has been described with the simulation results of the series connected converter. The smoothing of the energy from the linear generator can be achieved by the capacitor with high capacitive storage with series connected converter or by the super capacitor with parallel connected converter.

The vehicle and prime mover, the free piston engine, has been analyzed to synthetically consider the design requirements of the linear generator. The obtained results can enhance the design of the linear generator as the influence of the linear generator can be simulated in consideration of the fuel efficiency of REX-EV.

Acknowledgements

The authors would also like to thank the "Deutsche Forschungsgemeinschaft (DFG)" for the funding of the graduate school 1856 "Integrated Energy Supply Modules for On-Road Electro mobility".

References

- [1] Wang J., West M., Howe D. et al., *Design and experimental verification of a linear permanent magnet generator for a freepiston energy converter*. Energy Conversion, IEEE Transactions on 22(2): 299-306 (2007).
- [2] Zheng P., Chen A., Thelin P., Arshad W.M., *Research on a tubular longitudinal flux PM linear generator used for free-piston energy converter*. Magnetics, IEEE Transactions on 43(1): 447-449 (2007).
- [3] Xu Z., Siqin C., *Improved moving coil electric machine for internal combustion linear generator*. Energy Conversion, IEEE Transactions on 25: 2281-286 (2010).
- [4] Zheng P., et.al. *Research on the magnetic characteristic of a novel transverse-flux PM linear machine used for free-piston energy converter*, Magnetics, IEEE Transactions on 47(5): 1082-1085 (2011).
- [5] Cosic A., *Analysis of a novel transversal flux machine with a tubular cross section for free piston energy converter application*. (2010).
- [6] Ripaccioli G., et.al. *A stochastic model predictive control approach for series hybrid electric vehicle power management*. American Control Conference(ACC). IEEE, 2010, pp. 5844-5849 (2010).
- [7] Bernardini D., Bemporad A., *Scenario-based model predictive control of stochastic constrained linear systems*. Decision and Control, 2009 held jointly with the 2009 28th Chinese Control Conference. CDC/CCC 2009. Proceedings of the 48th IEEE Conference on. IEEE (2009).
- [8] André M., *The artemis european driving cycles for measuring car pollutant emissions*. Science of the total Environment 334: 73-84 (2004).
- [9] Cooley R.B., *Engine selection, modeling, and control development for an extended range electric vehicle*. Ph.D. dissertation, The Ohio State University (2010).
- [10] Schneider S., Rinderknecht F., Friedrich H. E., *Design of future concepts and variants of the free piston linear generator*. in Ecological Vehicles and Renewable Energies (EVER), 2014 Ninth International Conference on. IEEE, pp. 1-8 (2014).
- [11] Atkinson C.M., et.al. *Numerical simulation of a two-stroke linear enginealternator combination*, SAE Technical Paper, Tech. Rep. (1999).
- [12] Mikalsen R., Roskilly A., *The control of a free piston engine generator. part 2: Engine dynamics and piston motion control*. Applied Energy 87(4): 1281-1287 (2010).
- [13] Xu Z., SiQin C., *Development of a single-cylinder four stroke free-piston generator*. Advanced Materials Research 772 (2013).
- [14] Carter D., Wechner E., *The free piston power pack: Sustainable power for hybrid electric vehicles*, SAE Technical Paper 2003-01-3277 (2003).
- [15] Němeček P., Vysoký O., *Control of two-stroke free-piston generator*. Proceedings of the 6th Asian Control Conference 1 (2006).
- [16] Rinderknecht F., *A highly efficient energy converter for a hybrid vehicle concept-focused on the linear generator of the next generation*. Ecological Vehicles and Renewable Energies (EVER), 2013 8th International Conference and Exhibition on. IEEE (2013).
- [17] Aziz A.R.A., Rangkuti C., Baharom M., Iskandar B.S., *Dynamics of CNG-fuelled free-piston linear generator engine*. The 9th International Association for Natural Gas Vehicles Conference-Road to a Better World, Buenos Aires, Argentina (2004).
- [18] Johnson T.A., Leick M.T., *Experimental evaluation of the free piston engine-linear alternator (FPLA)*, No. SAND2015-2095. Sandia National Laboratories (SNL-NM), Albuquerque, NM (United States), (2015).
- [19] Brooking P.R.M., Mueller M.A., *Power conditioning of the output from a linear vernier hybrid permanent magnet generator for use in direct drive wave energy converters*, Inst. Electr. Eng. Proc. Generation Transm. Distrib. 152(5): 673-681 (2005).
- [20] Yoo H., Sul S.K., Park Y., Jeong J., *System integration and power-flow management for a series hybrid electric vehicle using super capacitors and batteries*, Industry Applications, IEEE Transactions on 44(1):108-114 (2008).
- [21] Seo U.J., Riemer B., Appunn R., Hameyer K., *The design requirements of a linear generator integrated in a free piston engine for range extender application*. Proc. Int. Conf. Linear Drives for Industry Applications (LDIA), Aachen, Germany (2015).