

**Stanisław GUZOWSKI\***, **Maciej MICHNEJ\***, **Grzegorz ZAJĄC\***

## **TRIBOLOGICAL WEAR OF WHEEL RIMS IN RAIL VEHICLES IN OPERATING CONDITIONS**

### **ZUŻYCIE TRIBOLOGICZNE WIĘNCÓW KÓŁ TOCZNYCH POJAZDÓW SZYNOWYCH W WARUNKACH EKSPLOATACJI**

#### **Key words:**

rail vehicles, wheel sets, wear

#### **Słowa kluczowe:**

pojazdy szynowe, zestawy kołowe, zużycie

#### **Abstract**

Wheel sets as elements determine the reliability and safety in railway traffic demand ensuring high technological and quality standards at the stage of production and exploitation. Not satisfying these conditions may result in, among others, premature wear of wheels in the wheel sets, in turn a shortening between-repair running periods and increasing the exploitation costs of rail vehicles. The authors, based on carried out tests, analysed the influence of not satisfying proper parameters of heat treatment of wheel rims on tribological

---

\* Cracow University of Technology, Institute of Rail Vehicles, Al. Jana Pawła II 37, 31-864 Kraków, Poland, tel. 12 374 33 10, e-mail: m-8@mech.pk.edu.pl.

wear on their surface. This especially concerns abrasive wear of wheel rims and damages of the spalling type on the wheel thread surface in wheel sets.

## INTRODUCTION

Wheel set are the most important elements of the running system of a rail vehicle. It ensures translatory motion of the vehicle and its running along the rail. The construction of a wheel set must be closely made for a given type of vehicle. It is connected, among others, with the drive transfer, the kind of brakes, the dimensions, and permissible vehicle speed. The safety aspect is especially important. No other rail vehicle set has such a great influence on traffic safety as the wheel set. Wheel sets demand ensuring high technological and quality standards at the stage of production and exploitation. Not satisfying these conditions may result in, among others, premature wear of wheels in the wheel sets and a shortening between-repair running periods and an increase in the exploitation costs of rail vehicles.

Especially essential is preserving proper profile and dimensions of a wheel thread and rim. These parameters and damages on the wheel thread determine the survey cycle of rail vehicles, including the sets, and decide wheels exchange.

The article presents the results of tests on the wheel sets for a chosen series of traction units partly exploited in particular areas.

## MONO-BLOCK WHEEL RIMS WEAR

The tested vehicles shared 50% of transportation work on the railway lines in mountainous areas, which means that they were exploited in difficult conditions. The wheel sets of these vehicles worked in the conditions of long lasting contact of the rim and the rail. Such a situation may cause, in the case of improper lubrication of the rims and when using materials having improper strength parameters or in the case of improper technological processes, premature wear of the wheel thread in the wheel sets. The basic parameters characterizing the rims are the rim thickness –  $O_g$ , the rim height –  $O_w$  and the rim steepness –  $q_R$  (**Fig. 1**). In the case of exceeding the boundary values of any of these parameters, it is necessary to roll the wheel thread. **Table 1** shows the average mileage of the vehicle between surface re-profiling of the wheel set due to exceeding the boundary values of the above-mentioned parameters.

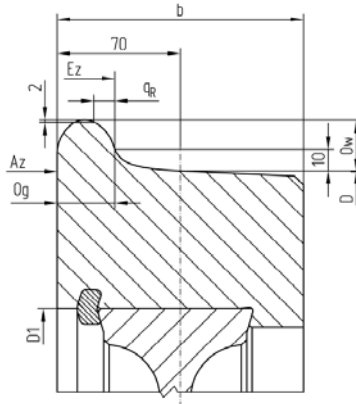

**Fig.1. Measurement places of  $O_w$ ,  $O_g$ , and  $q_R$  parameters**

Rys. 1. Miejsca pomiaru parametrów  $O_w$ ,  $O_g$ ,  $q_R$

**Table 1. The average mileage of the vehicle between surface re-profiling of the wheel**

Tabela 1. Średni przebieg pojazdu pomiędzy kolejnymi przetoczeniami profilu powierzchni tocznej zestawów kołowych

MILEAGE	FIRST	SECOND	THIRD
Mileage in thousands of km between surface re-profiling	94.4	42.4	27.5

In agreement with the construction and technological documentation and the conditions of tender, each re-profiling of the wheel set should take place only after the mileage of 100 000 km up to reaching a minimal rim wheel thickness, after which it is withdrawn from use. However, the results quoted in **Table 1** show totally different intensity of wheel rims wear. While at the beginning of exploitation, the rims wear until the first re-profiling satisfied the conditions in the documentation. In later re-profiling, they strayed from them. The second re-profiling took place after half the required mileage and the third one took place after approximately a third of the mileage.

It must be stressed that the macro-image of the wheel wear on the wheel thread aroused serious doubts in the sense of its proper cooperation with the rail, which was systematically removed during frequent forcing of re-profiling of the wheel outer profile due to wheel rim undercut. Macroscopic observations of the wheel thread of the wheel sets showed that there are various damages and wear on the wheels. The most characteristic ones are damages in the form of cracks and fatigue chippings on the wheel thread (shelling, spalling) (**Fig. 2**)

and the material delamination of the wheel thread in the form of shells followed by their rolling (**Fig. 3**).

Occurrence of a very differentiated character of wear and damages on the wheel thread proves that the tribological system consisting of a wheel and a rail is a complex one. Previous experience shows that the observed wear image is the result of simultaneous actions of numerous factors of constructional, technological, and exploitative characters [L. 1, 4]

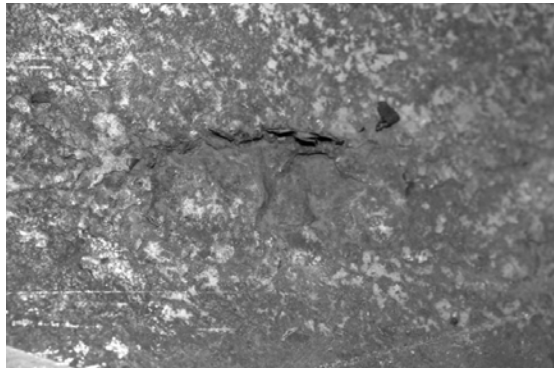

**Fig. 2. Damage of the wheel – cracks and fatigue chippings [L. 2]**

Rys. 2. Uszkodzenia na powierzchni tocznej koła – pęknięcia i wykruszenia zmęczeniowe [L. 2]

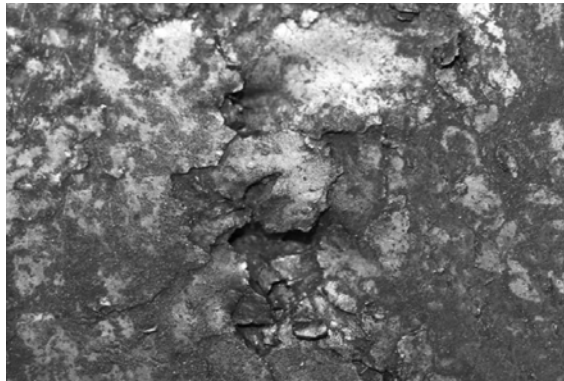

**Fig. 3. Damage of the wheel – delamination [L. 2]**

Rys. 3. Uszkodzenia na powierzchni tocznej koła – rozwarstwienia materiału w postaci łusek i ich rozwalcowanie [L. 2]

Constructional factors are the wheel diameter and profile (especially configuration in the transitory zone), running system geometry, and anti-torque resulting from the car body leaning on the truck frame.

Technological factors are the strength and structural parameters of the material, and the thermal treatment of the wheel outer surface profile.

Exploitation factors include permissible loading, the rails and turnouts, and the condition and lubrication systems of the rims during the vehicle journey along the rail arc.

Observations of the wheel threads show that the dominating processes are abrasive wear of the wheel rims and their plastic deformations. They are the main factors causing the necessity of the wheel thread re-profiling. Wheel rims wear intensity grows rapidly after the first mileage.

Wear intensity of the wheel threads and rims primarily depends on the mechanical properties of the wheel material, especially on HB hardness, tension strength  $R_m$ , and stresses in the surface layer [L. 1]. Not enough hardness and strength of the wheel material, in the case of contact with the rail hard surface, initiates intensive abrasive wear of the rim and plastic deformation of the wheel thread. To prevent this type of damage, the rim of the wheel set is submitted to thermal treatment. Therefore, a question arises about whether, in the case of tested sets, the treatment had been carried out correctly. In order to check this, material tests were carried out [L. 2].

## MATERIAL TESTS

Material tests included steel chemical constitution, Baumann printing, static tensile testing, hardness measurements, impact resistance tests, and steel microstructural evaluation and fractographic tests of the surface layer of the wheel thread. The tests were carried out in agreement with PN-EN 13262:2004 standard. While the results of chemical composition and Baumann printing were correct as for steels for wheel sets, the remaining results were considerably different [L. 2].

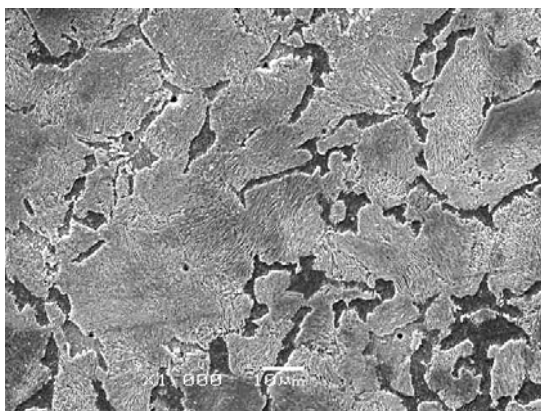
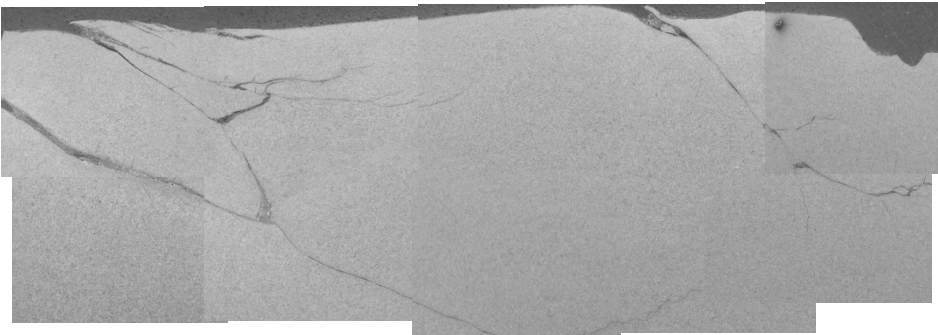

**Fig. 4. Examples of typical microstructure [L. 2]**

Rys. 4. Przykłady typowej mikrostruktury perlityczno-ferrytycznej w wieńcu koła monoblokowego [L. 2]

Mechanical property results for static tensile testing were worse than the data given as standard. None of the tensioned samples reached the required plastic boundary value. Hardness measurement results prove that hardness of all the wheels is less than the required minimal hardness values for wheels made of particular grades of steel [L. 2].

However, very interesting results were achieved in steel microstructure tests and in fractographic tests of the surface layer of the wheel rim. The most characteristic examples of registered deformations in the surface layer of the wheel rim are shown below [L. 2].



**Fig. 5. Grid of macro-cracks in the surface layer of the wheel rim [L. 2]**

Rys. 5. Siatka makropęknięć w warstwie wierzchniej wieńca koła monoblokowego [L. 2]

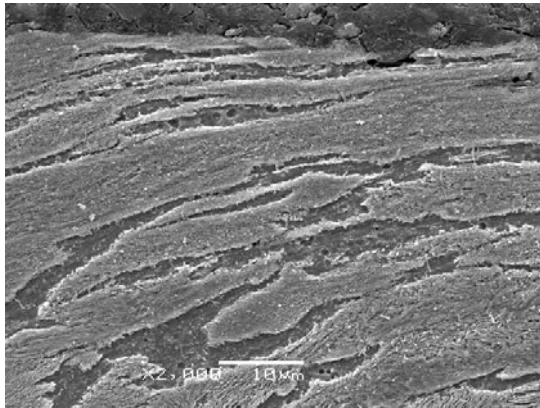

**Fig. 6. Plastic deformation of the surface layer of the wheel rim [L. 2]**

Rys. 6. Znaczne odkształcenie plastyczne mikrostruktury perlityczno-ferrytycznej warstwy wierzchniej wieńca koła [L. 2]

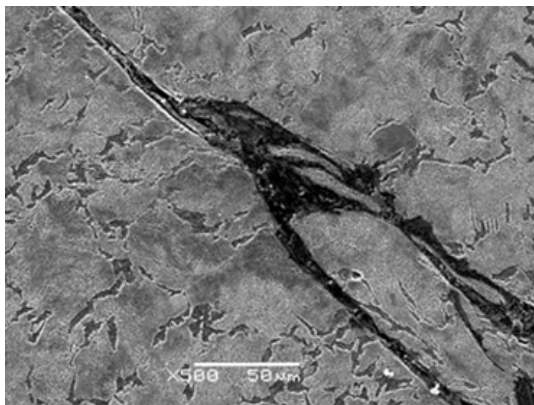

**Fig. 7. Example of cracking in the rim of the wheel [L. 2]**

Rys. 7. Przykład toru pęknięcia w wieńcu koła [L. 2]

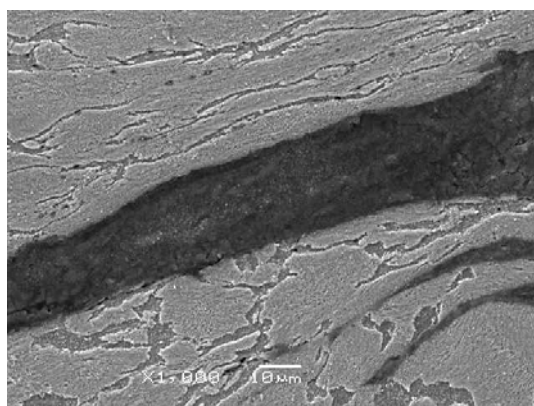

**Fig. 8. Plastic deformations of steel microstructure in the area of cracking [L. 2]**

Rys. 8. Plastikne odkształcenia mikrostruktury stali w obszarze toru pęknięcia [L. 2]

Steel microstructure tests were carried out using a scanning electron microscope. They showed that the used grade of steel has pearlite microstructure and behind the limits of pearlite grains there is a ferrite network. The structure of pearlite is lamellar and the average dimension of a pearlite grain is within 30–40  $\mu\text{m}$ . On the basis of detailed microscopic observations, it can be inferred that the wheel was not subjected to hardening process + tempering, because, in the surface layer, there was no steel microstructure characteristic of thermal treatment process in the form of martensite or bainite (after hardening), neither were there any tempering microstructures.

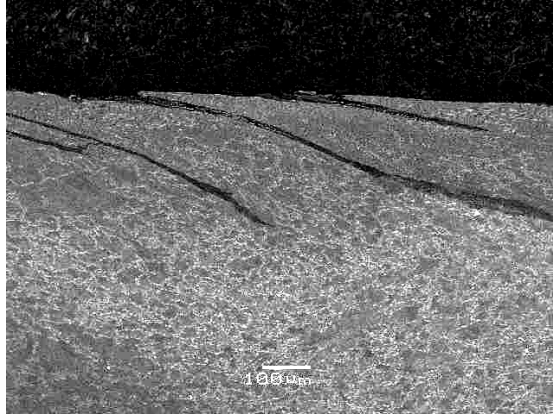

**Fig. 9. Macro cracks on the surface with significant plastic deformation microstructure [L. 2]**

Rys. 9. Makropęknięcia na powierzchni tocznej wieńca koła ze znacznymi odkształceniami plastycznymi mikrostruktury perlityczno-ferrytycznej [L. 2]

Fractographic tests of the samples from the wheel rim proved the existence of numerous exploitation macro cracks on the wheel thread in the form of tears of a characteristic shape of elongated tongues and shells. As it can be seen from the microphotographs, the formed cracks are partly filled with corrosion products.

In all the microphotographs taken in the surface layer of the wheel rims, traces of considerable plastic deformations can be observed. Plastic tears are the result of cooperation processes between the wheels and the rails during braking. On the track surface, tear nuclei are formed in the shape of elongated tongues oriented towards the friction force activity. Insufficient strength properties and hardness of the tested wheels are favourable for this phenomenon. These tears in the form of fissures with sharp tops are the cause of the propagation of fatigue cracks that may reach depth exceeding several millimetres. A change in the direction of the rotation of the exploited wheels and intensive braking is especially favourable for this phenomenon.

## CONCLUSIONS

The carried out tests showed that the material for mono-block wheels had been chosen according to the required standards; however, thermal treatment of the mono-block wheel rims had been carried out incorrectly. The rate of wear in the wheel rims and quoted results of metallographic tests show that hardening + tempering of the wheel rims had only been done superficially. The proof of this is the time between performing subsequent re-profiling of the wheel thread. In the microscopic tests, no steel microstructure characteristic of hardening process



in the form of martensite and bainite was observed as well as referring to them tempering microstructures.

Inadequate strength properties and hardness found for the wheel rims are favourable for an excessive abrasive and plastic wear of the rims and wheel threads. Fatigue cracks and chippings on the wheel surface result from flat spots and thermal cracks formed during momentary heating of the wheel due to friction between the wheel and the rail.

Images of wear and damages on the wheel surface of a wheel set show how essentially influential the processes of production are on the wear in the wheel sets in exploitation conditions.

## REFERENCES

1. Cegielný E. i inni: Określenie przyczyn nadmiernego zużycia zarysu zewnętrznego kół w zestawach kołowych wagonów transporterów typu MFS100-P. Instytut Pojazdów Szynowych, Politechnika Krakowska, Kraków, listopad 2006.
2. Cegielný E. i inni: Ustalenie przyczyn nadmiernego zużycia kół jezdných zestawów kołowych zespołów trakcyjnych. Instytut Pojazdów Szynowych, Politechnika Krakowska, Kraków, czerwiec 2013.
3. Kwaśnikowski J. i inni, Analiza przyczyn przyspieszonego zużycia powierzchni tocznych kół autobusu szynowego SA 108. Pojazdy Szynowe nr 2/2007.
4. Świdorski Z. i inni. Zużycie kolejowych pojazdów szynowych. Trakcja i Wagony nr 2/88,

## Streszczenie

**Zestawy kołowe jako elementy decydujące o niezawodności i bezpieczeństwie prowadzenia ruchu kolejowego wymagają na etapie wytwarzania i eksploatacji zapewnienia wysokich standardów technicznych i jakościowych. Nietrzymanie tych warunków skutkuje m.in. przyspieszonym zużyciem kół zestawów kołowych powodującym skrócenie przebiegów międzynaprawczych i zwiększenie kosztów użytkowania pojazdów szynowych. Autorzy na podstawie przeprowadzonych badań dokonali analizy wpływu nietrzymania właściwych parametrów obróbki cieplnej wieńców kół na zużycie tribologiczne występujące na ich powierzchni. Szczególnie dotyczy to zużycia ściernego obrzeży kół wraz z uszkodzeniami typu spalling na powierzchni tocznej kół zestawów kołowych.**

