

Research Concerning Electromagnetic Emissions from Residential On-grid PV Systems

Krzysztof Maniak, Janusz Sobolewski, Tomasz Tomczyk, Karolina Spalt, and Jacek Wroński

National Institute of Telecommunications, Poland

<https://doi.org/10.26636/jiit.2021.157021>

Abstract—The paper presents the results of grid power quality tests and wide frequency electromagnetic radiation level tests to which home power networks with photovoltaic systems have been subjected. The said results are meaningful from the point of view of safety and compatibility of electrical devices and the power supply system they are connected to. The tests covered stability of phase voltage and its frequency, harmonic level flicker, as well as RF radiated and emission levels. The measurements performed provide an answer to the question concerning the level of compliance of randomly selected home-installed PV systems with applicable recommendations and regulations concerning electromagnetic compatibility. The ability to meet the applicable standards translates into the health and safety of building inhabitants, which is the ultimate goal. Legal regulations concerning electromagnetic compatibility of renewable energy sources are consistent throughout the entire European Union.

Keywords—EMC, home-installed micro PV systems, photovoltaic power conversion, power grid quality, radiated emissions.

1. Introduction

The dynamic growth of global industry results in a significant increase in demand for energy. As it may be transmitted and transformed easily, electricity plays a major role in the process. Most power plants continue to generate energy by burning coal and lignite. This activity is accompanied by emissions of dust and carbon dioxide CO₂ [1]. Global CO₂ emissions equal 37.5 Gt [2] annually and have fallen slightly in 2020 due to rising coal prices [3]. If the situation persists, the estimated decrease in emissions could reach 2% per year. This fact causes, among other things, a worsening greenhouse effect and increases the average temperature of the globe.

Many outcomes of climate change caused by the use of coal are irreversible [4]. Numerous initiatives are being taken to limit these adverse phenomena [5]. For example, the World Meteorological Organization (WMO) aims to limit global average climate warming to 1.5°C by reducing CO₂ emissions by 2030 [6]. Therefore, it is desirable from the environmental point of view to look for alternatives to fossil

fuels, such as generated by wind power, water and solar radiation. Geothermal waters are used as an energy source as well [6]. Energy generated by water [7] has been known and used for a long time and accounts, globally, for 19% of electricity production.

In individual households, photovoltaic installations are becoming extremely popular. With the continued advances in the field of solar installations taken into consideration, it is predicted that the world's total energy production from these sources will exceed 1 TWh by the end of 2022 [8]. With the trends observed in the European Union in mind, one has to conclude that it is necessary to come up with even better legal regulations favoring green electricity sources [9]. The same applies to Poland as well [10]. In Poland, 80% of all sunny days are observed in during the spring and summer months, i.e. from April to August. The annual number of sunny hours is about 1,600 and the average power of solar energy per 1 m² of terrain ranges from 970 to 1070 W/m² [11]. Due to the high power of solar systems, there is a risk of undesirable electromagnetic issues to which household electrical appliances are subjected. The said radiation impacts the health of the residents as well. Interference caused by the inverter converting DC voltage coming from the photovoltaic panels into AC voltage of the power grid is the main risk factor here. There are also reports in the literature that panels of which the PV systems are made act as antennas releasing signals into their surroundings. Such aerials may emit undesired RF signals related to the operation of the inverter [12], [13]. PV panels may also act as antennas receiving signals from the environment [14], [15]. Therefore, it is worth checking the degree to which residential solar power systems meet the requirements of applicable electromagnetic compatibility regulations. Despite the fact that the individual components of a solar system possess certificates confirming their acceptable levels of radiated and conducted emissions [16], [17], the entire systems – due to the fact that they comprise numerous components that fails to comply with the commonly applied practices and recommendations – may act as sources of excessive EM emissions.

There are no reports in the literature on comprehensive EMC studies of residential solar systems. According to

the authors, such studies are capable of providing valuable input on the compliance of complex solar installations with the requirements imposed by applicable standards.

2. Types of PV Installations for Domestic Use

The most common renewable energy installations for home use rely on solar energy. They form a part of the building's power network and are connected to the public power grid (hence, they are referred to as on-grid systems). The capacity of the system is an important criterion impacting its connection to the power grid. In the European Union, the following types of installations are distinguished for all renewable energy sources [18]:

- micro-installations – with rated power below 50 kW, operating at low voltage levels of 230/400 VAC. The surplus energy is fed to the grid via the user's connection;
- small installations – with rated power between 50 and 500 kW, connected to grids whose voltage levels are lower than 110 kVAC;
- large installations – with a power rating of over 500 kW. These systems require a connection to the main power supply point.

Solar power plants with the capacity of less than 50 kW, i.e. micro-installations, are the most common solution used in detached houses. Strong market competition between companies specializing in the installation of such solar systems results in significant pricing-related pressure, thus leading to components of insufficient quality being used. Subsidies offered by national governments for installing solar cells are an important factor as well. With the above taken into consideration, solar systems stand the best chance of becoming a widespread solution among electricity generators relying on micro, small and large installations. An example of a residential photovoltaic system is shown in Fig. 1.

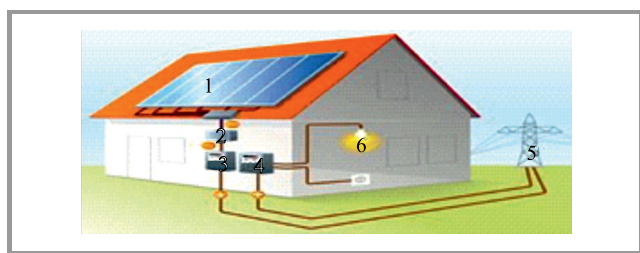

Fig. 1. Photovoltaic installation in a residential building: 1 – PV source of energy, 2 – inverter, 3 – feed-in, 4 – reference counter, 5 – power network, 6 – consumer appliances [19].

The DC voltage from the solar panels is converted into mains AC voltage by an inverter unit supplying energy to the consumer's appliances. The surplus electricity is fed back into the grid. Solar panels are the key component

of any photovoltaic installation. Their peak power varies between 250÷400 W per unit. Three generations of such panels are available on the market [20], [21]. However, the first-generation panels are still most commonly used in modern photovoltaic installations due to their moderate costs and high efficiency of up to 22%. The lifetime of this type of cells is estimated at about 25 to 30 years.

3. Electromagnetic Compatibility of Photovoltaic Systems

With the constantly growing number of residential PV installations taken into account, it is necessary to examine their impact on the operation of other devices connected to the power network or operating in the vicinity of such a system. It is the inverter and its auxiliary equipment that is the main source of interference. The device is, in fact, a DC-AC converter capable of feeding energy into the power grid. The process of converting energy relies on switched topologies [22]. While the base frequency does not exceed 200 kHz, harmonic frequencies and, hence, the EM fields emitted reach, due to fast switching several tens of MHz. This process is responsible for electromagnetic emissions and also affects the parameters of the power network to which the inverter is connected. In addition, EM interference propagates through the power wiring that may act as parasitic antennas.

In the majority of micro installations, inverters with the output power rating of 1÷10 kW are used. Such a high electric power rating raises concerns about the potentially excessive levels of electromagnetic disturbance which may exert a negative impact on the safety of residents and on the proper operation of other electronic and electrical appliances. Despite the fact that all components of the installation meet the applicable safety-related and EM regulations, it is difficult to say whether the combined multi-module installation will ultimately continue to meet the requirements set forth in the relevant standards. This depends on numerous factors, i.e. on compliance with recommendations concerning the process of their manufacture, assembly methods, quality of electrical connections, compatibility of electrical parameters between specific installation components, etc. It is often the case that such recommendations are not followed by the technicians installing the system, which leads to its improper operation, to an increased level of disturbances and to the degradation of the parameters of the building's electricity network. This, in turn, may result in interference affecting Wi-Fi networks, in malfunctions of mobile telephony and in problems with radio and TV reception. The influence of EM fields on human health depends on field strength, frequency and exposure time [23]. With the applicable standards taken into consideration [16], [24], we shall attempt to evaluate specific PV systems installed in residential buildings, assessing such parameters of the grid as voltage, frequency, harmonic content, flicker, etc. Electromagnetic disturbance emissions will be evaluated as

well. For installations in residential buildings, the measurements shall also cover the strength of the 50 Hz EM field.

4. EMC Measurements

An accredited EMC testing laboratory dealing with in-situ measurements performed tests of solar systems installed in two single-family houses, both using first generation monocrystalline photovoltaic cells. Both buildings are new, with their electrical systems complying with the current standards [25]. Figure 2 shows the schematic of the completed systems for both buildings. In the first one (Object 1), 11 JAP60S10-275/SC panels were installed on the roof, each generating 275 W, meaning that the total peak power equals 3.0 kW. A single-phase SOFAR 2700TL-G3 inverter with a rated power of 3.7 kW and auxiliary instrumentation was located in a utility room adjacent to the garage. Data communication devices, such as Wi-Fi and GPRS modems were built into the inverter. At the other location (Object 2), 21 Longi LR4-60HPH-370M monocrystalline panels of 370 W each were mounted on the roof, providing a total power of 7.7 kW. A three-phase inverter of the Solar Edge SE8k type was installed in the garage of the building. The unit is additionally equipped with built-in data transmission modules, such as Wi-Fi, GPRS, and ZigBee. These generate additional emissions recorded during the measurements of radiated disturbances. Both homes were equipped in a similar manner, with standard mains-powered household appliances (washing machine, fridge, microwave oven, boiler etc.), television sets and computers, as well as LED interior lighting. In addition, internal Wi-Fi networks exist in both homes. During the measurements, all pieces of equipment which may cause additional electromagnetic disturbances, such as computers, TVs, chargers, i.e. devices containing AC/DC converters, were switched off. Importantly, in both cases the measurement probes were located at the main power connection point. The inverter and the junction box between the photovoltaic system and the household grid were also located there. Measurements

were performed when the PV power generated was close to its maximum.

4.1. Power Network Quality Measurements

To assess the quality of the power network connected to a photovoltaic system, the criteria contained in standard [24] were applied. In both cases, power network parameters were measured using the Fluke 435 network quality analyzer. The measurement setup for the three-phase network is presented in Fig. 3, while Fig. 4 shows an image of the measuring station in Object 2.

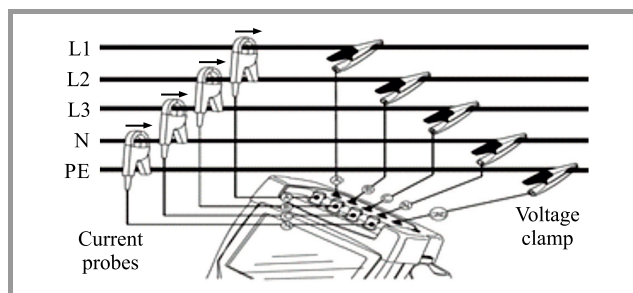

Fig. 3. Schematic diagram of the connection of the Fluke 435 power network analyzer to the grid.

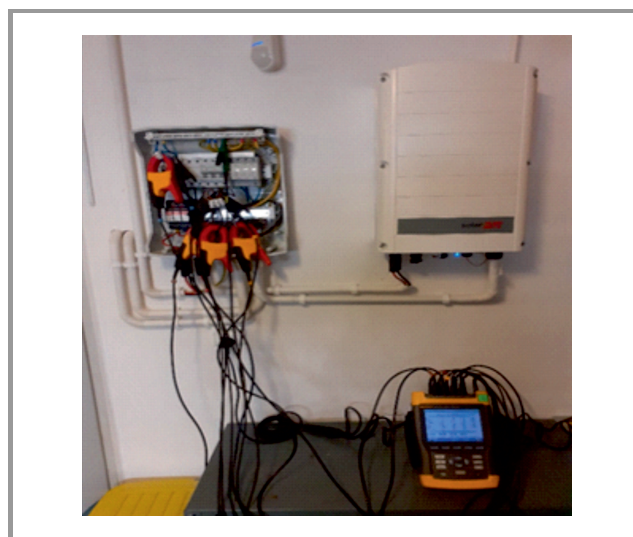

Fig. 4. Measurement station in Object 2.

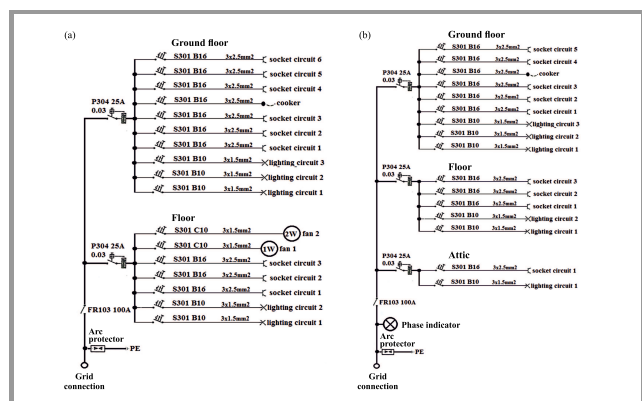

Fig. 2. Schematic diagram of the electrical system in Objects 1 (a) and 2 (b).

The root mean square value of the network voltage is defined by [26]:

$$V_{rms} = \sqrt{\frac{1}{T_W} \sum_{n=0}^{T_W} V_n^2}, \tag{1}$$

where T_W is the measurement window with a duration of 10 periods of the network’s AC voltage, V_n are the samples of the measured voltage.

The current measurement is carried out with the use of clamp probes. Such a solution ensures full safety due to the galvanic separation of the measurement circuit. For three-phase mains, the measurements were performed in a star

configuration. The rms value of the measured current is defined by [27]:

$$I_{rms} = \sqrt{\frac{1}{T_W} \sum_{n=0}^{T_W} i_n^2}, \quad (2)$$

where i_n are samples of the measured current. The flicker index is measured by the P_{lt} parameter, i.e. is a long-term value measured over a period of 2 hours based on 12 measurements of 10-minute flicker. The P_{lt} value is determined from:

$$P_{lt} = \sqrt[3]{\frac{\sum_{i=1}^{12} P_{sti}^3}{12}}, \quad (3)$$

where P_{sti} is the 10-min flicker value. According to standard [20], the measurement of total harmonic distortion in the mains voltage waveform should be a sum of first 40 harmonic components of the fundamental frequency [24]:

$$THD = \sqrt{\sum_{h=2}^{40} (V_h)^2}. \quad (4)$$

The voltage crest factor is defined by:

$$CF = \frac{V_{peak}}{V_{rms}}, \quad (5)$$

where U_{peak} is the amplitude of the voltage waveform. For a sinusoidal waveform, $CF = 1.414$. The power network parameter values obtained at both Objects are summarized in Table 1. In addition, shifts between the power network phase voltages were recorded for Object 2 (Fig. 5).

Table 1
Basic power network parameters in both objects

Object 1	Object 2		
L1	L1	L2	L3
AC voltage [V]			
252.44	236.67	240.40	240.98
Voltage crest factor			
1.42	1.40	1.40	1.40
Mains frequency [Hz]			
49.992	49.996	-	-
THD [%]			
2.3	2.8	3.0	2.9
Flicker P_{lt}			
0.31	0.24	0.37	0.83

Based on the measurements, one may observe that all relevant power network parameters are within the ranges specified in the standard [24]. The rms value of the AC voltage does not exceed the variation threshold of $\pm 10\%$, and frequency remains within the $\pm 1\%$ range. Similarly, THD of the mains voltage does not exceed the permitted 8% level and flicker does not exceed unity. Here, only the line voltage harmonics are included in measurements. This is

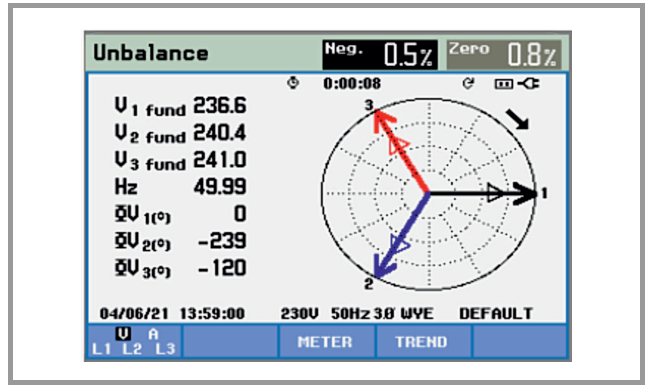

Fig. 5. Phase dependence of the 3-phase grid AC voltage at Object 2.

due to the fact that a sinusoidal voltage waveform is generated by the inverter circuit, as the PWM switching process significantly increases THD. On the other hand, the mains current's THD strongly depends on the grid load. For example, many switching power supply lines (without a PFC unit) have a diode bridge rectifier connected to a large capacitor at AC input. The current is then drawn in pulses, which causes significant distortion of waveforms and an increase in THD. Voltage relations and phase shifts for the three-phase grid in Object 2 are also in compliance with the related standard under which an asymmetry of up to 2% between phase voltages is permitted.

4.2. Radiated Emissions Measurements

The radiated emissions were examined within a frequency range that is crucial for the operation of electronic devices used at home and in accordance with standard [16]. The band under consideration is also important from the point of view of ensuring healthy living conditions for the residents. A biconical SAS-521F-7 antenna by A. H. Systems was used for V (vertical) and H (horizontal) polarity measurements. The tests were performed in the frequency range of 30 MHz ÷ 6 GHz. In accordance with the recommendations set forth in standard [16], the antenna was placed

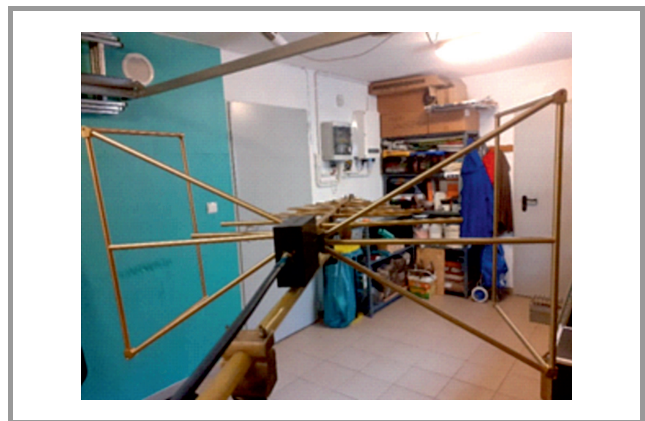

Fig. 6. Radiated emissions measurement setup – Object 2.

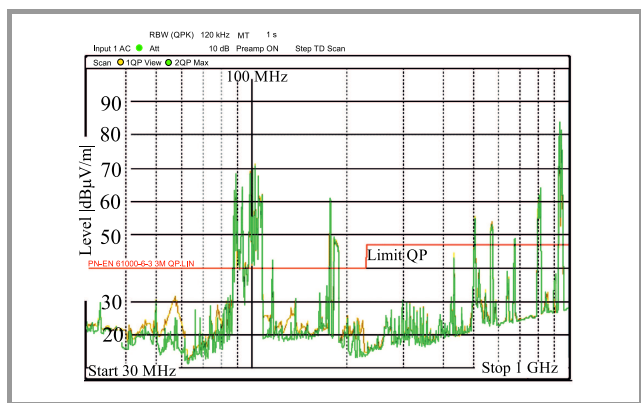

Fig. 7. Radiated emissions acquired at Object 1 for horizontal antenna polarity in the 30 MHz÷1 GHz band (green line – background level, yellow – QP emissions, red – applicable limits). (see the digital edition for color images)

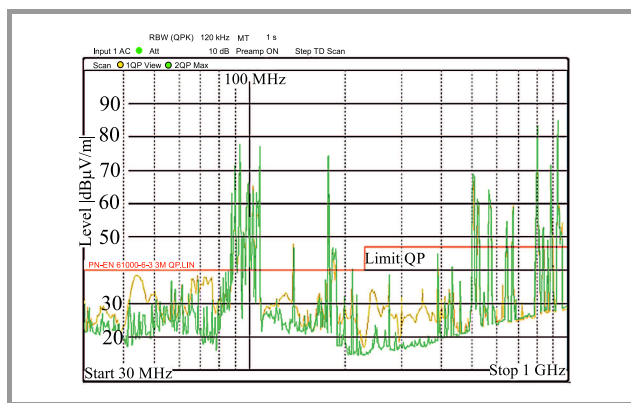

Fig. 9. Radiated emissions acquired at Object 2 for horizontal antenna polarity in the 30 MHz÷1 GHz band (green line – background level, yellow – QP emissions, red – applicable limits).

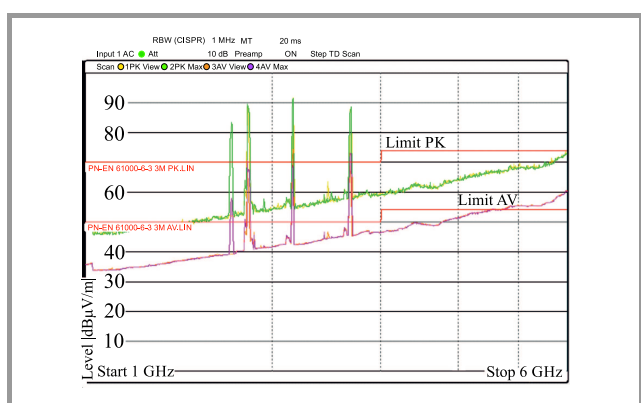

Fig. 8. Radiated emissions for Object 1, with horizontal antenna polarity in the 1 GHz÷6 GHz band (yellow – PK emissions, green line – background PK, orange – AV emissions, magenta – background AV, red – applicable limits).

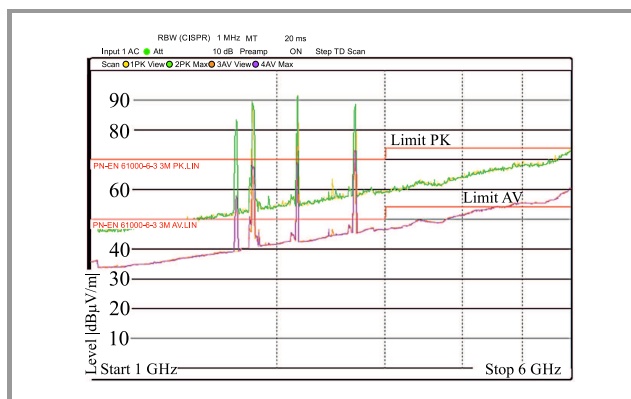

Fig. 10. Radiated emissions for Object 2, for horizontal antenna polarity in the 1 GHz÷6 GHz band (yellow line – PK emissions, green – background PK, orange – AV emissions, magenta – background AV, red – applicable limits).

at a distance of 3 m from the device undergoing the test (i.e. in the case of both locations, the inverter plus its auxiliary equipment). For the 30 MHz÷1 GHz band, standard [16] requires that a quasi peak (QP) detector be used. For the 1–6 GHz range, peak (PK) and average (AV) detectors were used. Measurements of the background level were performed with the inverter switched off, thus making it possible to observe EM signals present in the tested object and not related to the operation of the solar system. No significant variations were found in the results depending on antenna polarization. However, for both frequency ranges, results obtained with the measuring antenna in the horizontal configuration were considered. The measurements performed at both Objects are shown in Figs. 7–8 for Object 1, and in Figs. 9–10 for Object 2. The test bench used is shown in Fig. 6.

In the 30 MHz–1 GHz range we are interested with, areas could be identified at both Objects where the background signal considerably exceeded the permitted levels. For the 30 MHz–1 GHz band, main source of EM emissions includes FM radio waves which exceeded the permitted lev-

els in the region around the 100 MHz mark. The second big source of EM emissions present in the background includes, in most cases, signals from terrestrial DVB-T television. This is visible near the 180 MHz mark and in the 400 MHz–1 GHz band. In higher portions of spectrum, i.e. 1–6 GHz, one may notice signals of GSM transmitters: 1.8 GHz, 2.4 GHz, and 2.6 GHz. These may be eliminated from the measurement data. The radiated emissions generated by the inverter, i.e. the main source of EM disturbances, are within the limit allowed under the standard [16]. However, in Object 2 for instance, below the 80 MHz mark, the margin equals approx. 3–4 dB. This is visible for the waveform recorded in the vicinity of 45 and 60 MHz. The increase in radiated emissions is most probably caused by the operation of the inverter itself.

4.3. 50 Hz Electromagnetic Field Measurements

Due to the fact that the inverter is a source of 50 Hz voltage that (the same as in the power network) and works with high power, it is necessary to check whether the permissible levels of EM fields present in the proximity of this device

are not exceeded. The measurements were performed for residential building conditions, in accordance with standard [28]. For the 50 Hz mains frequency, the allowed values equal 5000 V/m for the electric field and 80 A/m for the magnetic component. Since no measurement distances from the tested device (inverter) are recommended, only the general recommendation was followed, namely the measurements were performed 0.3 m from the unit and 1.8 m above the floor. At this position, the maximum EM field strength was obtained for both Objects using a field intensity meter type HI-3604 by Holaday Industries. The location of the measurement sites is presented in Fig. 11, and a summary of the results obtained is given in Table 2.

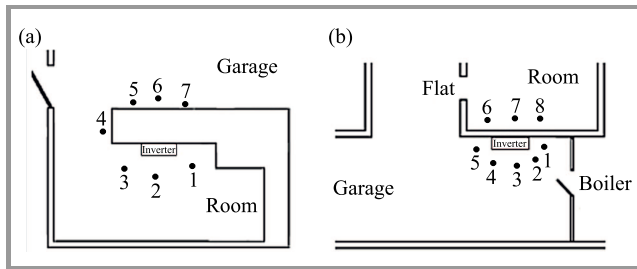

Fig. 11. Location of measurement points in Object 1 a) and Object 2 b).

During the measurements, power consumption of the household was close to maximum. The intensity of the relevant EM field components at each test point did not exceed the permitted level in close proximity to the inverter. Therefore, at other locations within the household, field strength values describing the mains frequency electromagnetic field will be correspondingly lower and thus safe for the environment.

Table 2
50 Hz electromagnetic field values for different measurement locations

No.	Object 1		Object 2		Evaluation
	Electric field [V/m]	Magnetic field [mA/m]	Electric field [V/m]	Magnetic field [mA/m]	
1	51.6	90.0	18.7	583.2	No issues
2	61.4	47.4	12.2	489.6	
3	44.2	39.3	47.3	432.0	
4	29.0	20.5	44.8	295.2	
5	36.5	17.3	9.8	316.8	
6	29.2	14.2	79.9	108.0	
7	35.5	22.2	52.8	236.2	
8	-	-	39.5	210.6	

5. Propagation of Radiated Disturbances

It should be noted that the strength of the electric field was measured in accordance with household-applicable standards, in close proximity to the source, i.e. the inverter

and its auxiliary equipment. In such a scenario, the issue of spatial distributions of the emitted EM disturbances at longer distances from the source may arise. However, due to the complex propagation conditions prevailing in houses, it is difficult to determine unambiguous propagation paths of the disturbances emitted by the PV system’s secondary components. The degree of susceptibility of electronic devices depends on their location in the household and it is difficult to precisely determine the position of the residents at a given time of the day. In this case, the propagation of the EM field in a homogeneous semi-conductive medium with variable characteristic parameters should be considered.

The source of EM disturbances originating from the inverter along with its auxiliary equipment, due to the fact that its size is small in relation to the entire building with the solar system installed, may be presented in the form of an electric dipole placed at the beginning of the Cartesian coordinate system and oriented along the z axis, as pictured in Fig. 12.

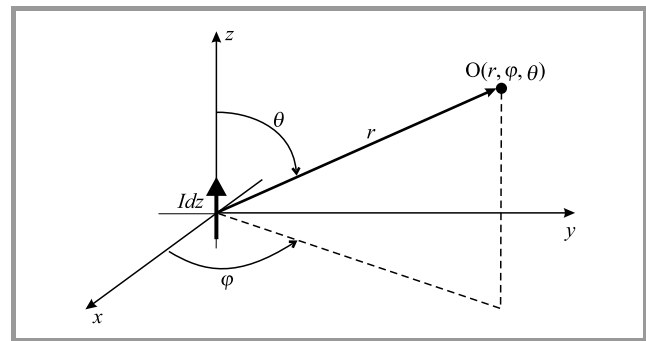

Fig. 12. Electromagnetic field of an electric dipole placed in a homogeneous semiconductive medium.

The semiconductive medium in which the electromagnetic field of the electric dipole is propagated is characterized by [29]:

- magnetic permeability $\mu = \mu_1 \cdot \mu_0$ [H/m],
- electric permeability $\epsilon = \epsilon_1 \cdot \epsilon_0$ [F/m],
- electrical conductivity σ [S/m],
- specific electrical resistance $\rho = 1/\sigma$ [Ω m].

On this basis, it is possible to determine the important parameter of the medium, i.e. the wave number expressed by [29]:

$$\gamma = \sqrt{\frac{i\omega\mu}{\rho} - \epsilon\mu\omega^2} = \sqrt{i\omega\mu(\sigma + i\omega\epsilon)}, \quad (6)$$

where ω is the pulsation [rad/s].

The EM field components expressed in spherical coordinates for the observation point O (see Fig. 12) take the form [30]:

$$E_r = \frac{-Idz}{4\pi} \cdot 2i\omega\mu \cos Q \frac{e^{i\gamma r}}{\gamma^2 r^3} (1 - i\gamma r), \quad (7)$$

$$E_\theta = \frac{-Idz}{4\pi} \cdot i\omega\mu \sin Q \frac{e^{i\gamma r}}{\gamma^2 r^3} (1 + \gamma^2 r^3 - i\gamma r), \quad (8)$$

$$H_\phi = \frac{Idz}{4\pi} \cdot \sin Q \frac{e^{i\gamma r}}{r^2} (1 - i\gamma r). \quad (9)$$

The values of field strength components depend not only on the specification of the propagation medium, but also on the frequency and distance from the source of RF energy. Under real conditions, it would be necessary to create a wideband computational model of each object or to analyze data using the relations given in Eq. (7)–(9). It may be assumed that the values of the EM field strength components decrease with distance. In this case, it will be necessary to perform tests of electric field strength in the vicinity of the expected source of emissions and to assess whether the obtained values do not exceed the levels permitted under the standard. At longer distances from the radiation source, field strength values will be lower than the ones that have been measured. This is because in an average interior, there are several surfaces reflecting and absorbing EM radiation [31], [32]. This causes a reduction in the levels of emitted fields, with the degree of such a reduction being a function of the distance from the source.

6. Conclusion

The paper attempts to assess whether domestic PV systems pose a risk to residents and to the electrical infrastructure, under normal conditions in which solar installations operate. In order to answer this question, extensive research related to electromagnetic compatibility needs to be conducted. In the case of electrical installations working together with renewable energy sources, tests of basic power network quality parameters are recommended, such as effective value of the mains voltage, frequency, THD, flicker and other factors, depending on the operating conditions prevailing at a given location. In addition, for the sake of the household members and to avoid malfunctioning of the electrical appliances, it is necessary to measure the RF emissions generated by the devices performing switched mode energy conversion. In photovoltaic systems, this includes the inverter and its auxiliary equipment. In order to ensure the safety of humans, it is important to measure the intensity level of 50 Hz mains fields. It is recommended to assess the acquired values based on standards applicable to residential installation. The test campaign performed by the authors and covering two randomly selected domestic PV micro-installations shows that the compliance of the power network with the recommendations set forth

in the standards is ensured. Similarly, the measurement of high-frequency electromagnetic field emissions in the 30 MHz÷6 GHz range did not identify and situations in which the levels permitted under the standard would be exceeded. This means that the installations are safe from the point of view of their users. The measurements of specific electromagnetic field components at the mains frequency failed to identify any risks or additional threats that people could be subjected to as well.

Acknowledgement

The authors would like to thank Tomasz Gurdziałek for agreeing to perform the measurement campaigns of photovoltaic systems installed at his home.

References

- [1] R. D. Bressler, "The mortality cost of carbon", *Nature Commun.*, no. 12, 2021 (DOI: 10.1038/s41467-021-24487).
- [2] Emission Gap Report 2019, *United Nations Environment Programme* [Online]. Available: <https://www.unep.org/resources/emissions-gap-report-2019>
- [3] J. F. Green, "Does carbon pricing reduce emissions? A review of ex-post analyses", *Environmental Research Letters*, vol. 16, no. 4, 2021 (DOI: 10.1088/1748-9326/abdae9).
- [4] S. Solomona, G. K. Plattner, R. Knutti, and P. Friedlingstein, "Irreversible climate change due to carbon dioxide emissions", in *Proc. of the National Academy of Sci. of the United States of America*, vol. 106, no. 6, 2009 (DOI: 10.1073/pnas.0812721106).
- [5] F. L. Suocheng Dong, Z. Li, Y. L. Shantong Li, and Y. Wan, "The improvement of CO2 emission reduction policies based on system dynamics method in traditional industrial region with large CO2 emission", *Energy Policy*, vol. 51, pp. 683–695, 2012 (DOI: 10.1016/j.enpol.2012.09.014).
- [6] V. Masson-Delmotte *et al.*, "Global warming of 1.5°C", IPCC Special Report, *Intergovernmental Panel on Climate Change*, 2019 [Online]. Available: <https://www.ipcc.ch/sr15/download/>
- [7] V. Laxmi Kalyani, M. Kumari Dudy, and S. Pareek, "Green energy: the need of the world", *J. of Management Engineer. and Informat. Technol.*, vol. 2, no. 5, 2015 [Online]. Available: https://www.researchgate.net/publication/283482870_GREEN_ENERGY_The_NEED_of_the_WORLD
- [8] S. Chowdhury *et al.*, "An overview of solar photovoltaic panels' end-of-life material recycling", *Energy Strategy Reviews*, vol. 27, 2020 (DOI: 10.1016/j.esr.2019.100431).
- [9] A. Pegels, G. Vidican-Auktor, W. Lu Tkenhorst, and T. Altenburg, "Politics of green energy policy", *J. of Environment & Development*, vol. 27, no. 1, pp. 26–45, 2018 (DOI: 10.1177/1070496517747660).
- [10] J. Kiciński, "Green energy transformation in Poland", *Bull. of the Polish Academy of Sci. Technic. Sci.*, vol. 69, no. 1, 2021 (DOI: 10.24425/bpasts.2020.136213).
- [11] A. Dobrzycki, D. Kurz, S. Mikulski, and G. Wodnicki, "Analysis of the impact of building integrated photovoltaics (BIPV) on reducing the demand for electricity and heat in buildings located in Poland", *Energies*, vol. 13, no. 10, 2020 (DOI: 10.3390/en13102549).
- [12] H. Lgarashi and S. Suenaga, "Electromagnetic noise from solar cells", in *Proc. Conf. Record of the Thirty-first IEEE Photovoltaic Specialists Conf.*, Lake Buena Vista, FL, USA, 2005 (DOI: 10.1109/PVSC.2005.1488506).
- [13] C. Jettanasen and C. Pothisarn, "Performance and electromagnetic interference mitigation of DC-DC converter connected to photovoltaic panel", *Int. J. of Smart Grid and Clean Energy*, vol. 8, no. 6, pp. 806–812, 2019 (DOI: 10.12720/sgece.8.6.806-812).

- [14] C. Baccouch, D. Bouchouicha, H. Sakli, and T. Aguilu, "Patch antenna based on a photovoltaic cell with a dual resonance frequency", *Adv. Electromag.*, vol. 5, no. 3, pp. 42–49, 2016 (DOI: 10.7716/aem.v5i3.425).
- [15] M. Drapalik, J. Schmid, E. Kancsar, V. Schlosser, and G. Klinger, "A study of the antenna effect of photovoltaic modules", *Int. Conf. on Renewable Energ. and Power Quality (ICREPQ'10)*, Granada, Spain, pp. 371–375, 2010 (DOI: 10.24084/REPQJ08.333).
- [16] Standard EN 61000-6-3, "Electromagnetic compatibility (EMC) – Part 6-3: Generic standards – Emission standard for residential, commercial and light-industrial environments", 2008/A1:2012 [Online]. Available: <https://webstore.iec.ch/publication/27413>
- [17] Standard EN 61000-6-4, "Generic standards – Emission standard for industrial environments", 2019 [Online]. Available: <https://webstore.iec.ch/publication/26622>
- [18] S. Bartnikowska, A. Olszewska, and W. Czekala, "The current state of connection issues of renewable energy sources installations to the electrical grid", *Energy Policy J.*, vol. 20, no. 2, pp. 117–128, 2017 [Online]. Available: <https://epj.min-pan.krakow.pl/pdf-96172-28949?filename=The%20current%20state%20of.pdf> (ISSN: 14296675) (in Polish).
- [19] "How a photovoltaic installation works" [Online]. Available: <https://2quantumenergy.com/functioning-of-pv-systems/>
- [20] K. Ranabhat *et al.*, "An introduction to solar cell technology", *J. of Applied Engineer. Sci.*, vol. 14, no. 405, pp. 481–491, 2016 (DOI: 10.5937/jaes14-10879).
- [21] M. Arun, "Types of solar cells and its applications", *Int. J. of Sci. Devel. and Res.*, vol. 4, no. 2, pp. 260–267, 2019 [Online]. Available: <https://www.ijedr.org/papers/IJEDR1902043.pdf> (ISSN: 24552631).
- [22] W. Mao *et al.*, "A research on cascaded H-bridge module level photovoltaic inverter based on a switching modulation strategy", *Energies*, vol. 12, no. 10, 2019 (DOI: 10.3390/en12101851).
- [23] A. B. Rifai and M. A. Hakami, "Health hazards of electromagnetic radiation", *J. of Biosciences and Medicines*, vol. 2, pp. 1–12, 2014 (DOI: 10.4236/jbm.2014.28001).
- [24] Standard EN 50160, "Voltage characteristics in public distribution system", 2010 [Online]. Available: <https://standards.iteh.ai/catalog/standards/clc/18a86a7c-e08e-405e-88cb-8a24e5fedde5/en-50160-2010>
- [25] Standard PN-IEC 60364, "Electrical installations in buildings", 2000 (in Polish).
- [26] J. M. Flores-Arias *et al.*, "A memory-efficient true-RMS estimator in a limited-resources hardware", *Energies*, vol. 12, no. 9, 2019 (DOI: 10.3390/en12091699).
- [27] K. Zhou and L. Cai, "An algorithm for calculating the RMS value of the non-sinusoidal current used in AC resistance spot welding", *J. of Power Electron.*, vol. 15, no. 4, pp. 1139–1147, 2015 (DOI: 10.6113/JPE.2015.15.4.1139).
- [28] Standard EN 62233, "Measurement methods for electromagnetic fields of household appliances and similar apparatus with regard to human exposure", 2008 [Online]. Available: <https://standards.iteh.ai/catalog/standards/clc/a0bd973c-5a39-4cfa-8261-a474cd6a392f/en-62233-2008>
- [29] K. Maniak, "Badanie zjawisk elektromagnetycznych występujących na osuwiskach (The study of electromagnetic phenomena to landslides)", Doctoral Dissertation, Wrocław University of Technology, Wrocław, Poland, 2008 (in Polish).
- [30] J. Miecznik, "Electromagnetic fields of dipole sources", *Geologia*, vol. 37, pp. 37–61, 2011 [Online]. Available: <http://yadda.icm.edu.pl/yadda/element/bwmeta1.element.baztech-article-AGHL-0002-0002/c/Miecznik.pdf> (in Polish).
- [31] A. Choroszucho and B. Butrylo, "Local attenuation of electromagnetic field generated by wireless communication system inside the building", *Przegląd Elektrotechniczny*, vol. 87, pp. 123–127, 2011 [Online]. Available: <http://pe.org.pl/articles/2011/7/31.pdf>
- [32] I. Kolcunová *et al.*, "Influence of electromagnetic shield on the high frequency electromagnetic field penetration through the building material", *Acta Physica Polonica*, vol. 131, pp. 1135–1137, 2017 (DOI: 10.12693/APhysPolA.131.1135).

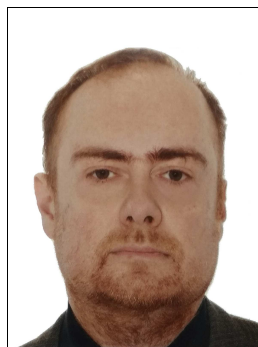

Krzysztof Maniak received his M.Sc. and Ph.D. degrees in Electronics from Wrocław University of Technology, Poland, in 2001 and 2008, respectively. Since 2012, he has been with the National Institute of Telecommunications in Wrocław. He is an author and co-author of numerous research papers and publications. His

professional work focuses on: power systems, electromagnetic compatibility and design of measuring equipment. He also participates in research and measurement-related activities. His research interests focus on the testing of power grid quality and its broadband interference protection.

 <https://orcid.org/0000-0003-1974-909X>

E-mail: k.maniak@il-pib.pl

National Institute of Telecommunications

Szachowa 1

Warsaw, Poland



Tomasz Tomczyk received his M.Sc. degree from the Faculty of Electronics, Wrocław University of Technology, in 2005. Since 2012, he has been with the National Institute of Telecommunications in Wrocław. He works at the EMC research laboratory. His interests cover broadly defined EMC research topics, especially in-situ

testing.

 <https://orcid.org/0000-0003-2870-9241>

E-mail: t.tomczyk@il-pib.pl

National Institute of Telecommunications

Szachowa 1

Warsaw, Poland



Karolina Spalt received her M.Sc. degree in Electronics from Wrocław University of Technology, Poland, in 2006. Since 2006, she has been with the National Institute of Telecommunications in Wrocław. She is an author and co-author of numerous research papers and publications. Her professional work focuses on:

electromagnetic compatibility, calibration of measurement equipment and measurement of electromagnetic fields. She is the head of the Laboratory of EMC Measuring Apparatus and participates in research and measurement-related activities.

E-mail: k.spalt@il-pib.pl

National Institute of Telecommunications
Szachowa 1
Warsaw, Poland



Janusz Sobolewski received his Ph.D. degree in Electronics from Wrocław University of Technology, Poland, in 1980. Since 1980, he has been an Assistant Professor with the National Institute of Telecommunications in Wrocław and the head of the EMC Department at NIT Wrocław (2005–2019). His research interests include fre-

quency management and frequency coordination (national and international), radio network analysis, planning and optimization, as well as electromagnetic compatibility of radio networks.

 <https://orcid.org/0000-0001-5816-8461>

E-mail: j.sobolewski@il-pib.pl

National Institute of Telecommunications
Szachowa 1
Warsaw, Poland



Jacek W. Wroński received his Ph.D. degree from Wrocław University of Technology (Poland). He is the Chief Research and Scientific Specialist at the Spectrum Management and Engineering Section of the EMC Department of the National Institute of Telecommunications, National Research Institute, Poland. Over the period

of more than 25 years, he has developed numerous software solutions and tools used in radiocommunications. He is interested in programming-related aspects, especially in efficiency and accuracy of optimization, stability of numerical method, multithreading, massive parallel computation and remoting. He is the author or co-author more than 120 NIT Reports (scientific and commercial), as well as over 20 conference papers and publications.

 <https://orcid.org/0000-0002-0452-3541>

E-mail: j.wronski@il-pib.pl

National Institute of Telecommunications
Szachowa 1
Warsaw, Poland