

GPON, the Ultimate Pertinent of Next Generation Triple-play Bandwidth Resolution

D. M. S. Sultan^a and Md. Taslim Arefin^b

^a Chalmers University of Technology, Gothenburg, Sweden

^b Daffodil International University, Dhanmondi, Bangladesh

Abstract—Optical transmission is getting more popular in the access network due to the increasing demand for bandwidth. New services like IP television (IPTV) transmission, video on demand (VoD) etc. over Internet together along high speed Internet access are confronting the demand of higher bandwidth at the customer end in today's Ethernet network backbone. Even though today's well deployed XDSL (i.e., VDSL/VDSL2+, SHDSL) solutions can satisfy bandwidth demand but are limited to the restriction regarding distance. Hereby, the suitable solution for high bandwidth demand with a long reach can be met by reaching optical cable to customer end directly. One of the possible ways would be to install passive optical network (PON). Gigabit PON (GPON) is the far-most advanced PON solution used by European and US providers while providers in Asia predominantly use EPON/GePON. This GPON is the basic technology to support the structure of the next-generation fiber to the home (FTTH) system. This paper provides an overview of such GPON solution associating its network architecture, transmission mechanisms and some key services.

Keywords—FTTH, Gigabit PON (GPON), IPTV, OLT, ONU, PON, VOIP.

1. Introduction

In today's increasingly competitive and technologically advanced telecom environment, broadband networks offer telecom operators both new business opportunities and new challenges. Carriers are now confronted with some problems: customer losing, revenue decreasing, investment risk, high operational expense (OPEX), etc. At the same time, subscribers need more suitable services, more personalized applications with high bandwidth consumption as well as quicker troubleshooting to support a vast array of voice/data/internet services. Carriers must resolve these issues in the stages of constructing, operating and upgrading their networks by deploying gigabit passive optical network (GPON) of today.

Along with increasing requirements of broadband access from residential customer and business customer, broadband access network has become urgent constructing network to carrier. Fiber technique has become mainstream and mature technique to develop broadband access. The growth of fiber to the home (FTTH) subscribers also gives an opportunity to deliver value-added services (viz. triple

play solution such as Internet, voice and video) on the same infrastructure based on the new FTTH architecture.

The subscribers' requirements on the bandwidth keeps growing, so application of purely fibers in the access network are the direction for broadband development, and the FTTH solution becomes the focus of the operators in developing the network. As per today's telecom market, all telecom vendors provide optical line terminal (OLT) that would smoothly inherit the GPON access but also support the ADSL2+, VDSL2, and voice over IP [1]. So far evaluated GPON solution by all vendors like Huawei, Ericsson, and Motorola etc. is such a unified and powerful platform that not only provides FTTx (fiber to the home, building, curb, node, etc.) solution but also provides the option to merge into next generation network (NGN) platform of fixed mobile convergence concept. Besides, advanced GPON solution of today is not only complying with FTTH, but also amenable with fiber to the curb (FTTC), to fiber to the building (FTTB) in case of some specific scenarios.

Currently, GPON interfaces can transmit services over passive optical fibers at a symmetrical bit rate of 1.25 Gbit/s or an asymmetrical bit rate of 2.5 Gbit/s downstream and 1.25 Gbit/s upstream for a distance of 20 km. In downstream, GPON OLT transmits encrypted user traffics over the shared bandwidth. In upstream, it uses time division multiple access (TDMA) technology to provide shared high-bit-rate bandwidth. Meanwhile, GPON OLT supports dynamic broadband algorithm, making the distribution of bandwidth to optical network unit (ONU) more flexible [2], [3]. In a glance, this paper aims to represent the GPON's competence of meeting the constant rising triple play bandwidth demand to next generation broadband solution architects.

2. GPON Architecture

In core GPON solution, the OLT is placed in the central office to provide the GPON access mode; splitters at the entrance of the residential block or near the management office of the residential block. For the FTTH, ONT series are provided directly in the multimedia box of each subscriber. For the FTTB, the remote ONU could be placed near the building to support ADSL2+, VDSL2, G.SHDSL

technologies to utilize the existing twisted pair resource. All equipments are directly connected with optical fibers. The integrated access platform OLT realizes the flexible access infrastructure depending on the different scenario to operator requirement.

Also, all of the equipments including the OLT, optical network unit/multi dwelling unit (ONU/MDU) and ONT can be managed by the broadband network management server to realize the end to end management solution. A total GPON architecture is shown in Fig. 1 amenable with NGN and Internet platform.

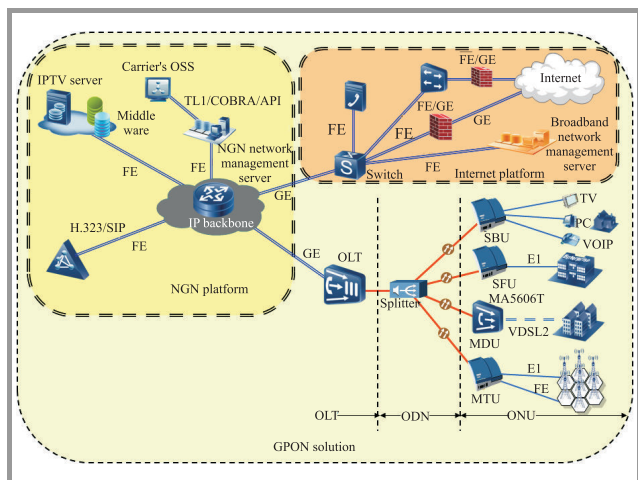

Fig. 1. GPON architecture along with NGN and Internet platform.

For business subscribers and individuals who accept the shared optical channel and a guaranteed bandwidth of less than 100 Mbit/s, the point to multipoint (P2MP) fiber access technology, which is based on the GPON, is an ideal choice. When the GPON is adopted, the bandwidth allocation of each subscriber could be flexible adjusted as per splitting ratio. So far 1:64 ratio is popular in GPON deployment, thus the average guaranteed bandwidth for each subscriber can reach up to 39 Mbit/s. So, bandwidth requirements for various broadband services, such as high-definition IPTV, can be satisfied.

When subscribers are dispersed and each requires a large guaranteed bandwidth and extreme private optical channel, the P2P fiber access technology can be adopted. The P2P scheme can meet the large bandwidth requirements of high-value subscribers and so as can be treated as a premier substitution of choice for high-value business subscribers, such as banks.

3. Why GPON?

In evolution from P2P to PON technologies, APON, BPON, EPON, GPON and WDM-PON named several PON technologies have been come from industrial and academics research collaboration yet. Among them two rival technologies are EPON and GPON. Regarding incessant re-

quirement of bandwidth, next generation PON would be 10GEPON, WDM-PON or Hybrid WDM/TDM-PON and a comparative summary among the PON technologies are shown in Table 1.

In EPON, both downstream and upstream line rates are 1.25 Gbit/s but due to the employment of 8 B/10 B line encoding, the bit rate for data transmission is of 1 Gbit/s only. On the other hand, in GPON, several upstream and downstream rates are specified up to 2.48832 Gbit/s, since GPON standard is defined in the ITU-T G.984.x series of recommendations [5] and it refers the bit rates of the conventional TDM systems. Guard time is the time between two neighboring time slots used for differentiating the transmission from various ONUs. In EPON, it is composed of laser on-off time, automatic gain control (AGC) and clock-and-data recovery (CDR). IEEE 802.3ah standard [6] has specified values (classes) for AGC and CDR but in GPON, guard time consists of laser on-off time, preamble and delimiter. According to the ITU-T G.984 recommendation, GPON has obviously shorter guard time than EPON [2]. However, it requires stricter physical layer constraints than EPON. Multi-point control protocol (MPCP) is implemented at the medium access control (MAC) layer in EPON to perform the bandwidth allocation, auto-discovery process and ranging. Two control messages, REPORT and GATE are used for defining dynamic bandwidth allocation [6]. Normally, a GATE message carries the granted bandwidth information from the OLT to an ONU in the downstream direction, while a REPORT message is used by an ONU to report the bandwidth request to the OLT in the upstream direction. This message exchange allows the time slots to be assigned according to the traffic demand of each individual ONU depending upon the available bandwidth. The size of REPORT and GATE message is 64 B which is equal to the shortest Ethernet frame. Furthermore, the EPON standard does not support frame fragmentation. Both OLT and ONUs can directly send and receive Ethernet frames with variable length.

In the contrary, GPON guard time is based on the standard of 125 μ s periodicity. This periodicity provides significant advantages compared to EPON. Messages, such as control, buffer report and grant messages can be efficiently integrated into the header of each 125 μ s frame. In order to pack Ethernet frames into the 125 μ s frame, Ethernet frame fragmentation has been introduced as well in GPON. Within GPON, each Ethernet frame or frame fragment is up to 1518 B and is encapsulated in a general encapsulation method (GEM) frame where GEM header is of 5 B. Status report message in GPON DBA is known as the overhead that requires 2 B. Upstream QoS awareness has also been integrated in the GPON standard with an introduction of the concept of transport containers (T-CONTs). T-CONT represents a class of service. Hence, GPON can provide a simple and efficient means for setting up a system for multiple service classes. Saying all these comparative technical issues of GPON and EPON comparative analysis, it could be sum up that GPON clearly leading forward than EPON to the current context.

Table 1
A comparative presentation among different PONs [4]

	A/BPON	EPON (GEAPON)	GPON	10GEAPON	WDM PON
Standard	ITU-T G.983	IEEE 802.3ah	ITU-T G.984	IEEE 802.3av	ITU-T G.983
Data packet cell size	53 B	1518 B	53 to 1518 B	1518 B	Independent
Maximum downstream line rate	622 Mbit/s	1.2 Gbit/s	2.4 Gbit/s	IP 2.4 Gbit/s Broadcast 5 Gbit/s On demand 2.5 Gbit/s	1–10 Gbit/s per channel
Maximum upstream line rate	155/622 Mbit/s	1.2 Gbit/s	1.2Gbit/s	2.5 Gbit/s	1–10 Gbit/s per channel
Downstream wavelength	1490 and 1550 nm	1550 nm	1490 and 1550 nm	1550 nm	Individual wavelength/channel
Upstream wavelength	1310 nm	1310 nm	1310 nm	1310 nm	Individual wavelength/channel
Traffic modes	ATM	Ethernet	ATM Ethernet or TDM	Ethernet	Protocol independent
Voice	ATM	VoIP	TDM	VoIP	Independent
Video	1550 nm overlay	1550 nm overlay/IP	1550 nm overlay/IP	IP	1550 nm overlay/IP
Max PON splits	32	32	64	128	16/100's
Max distance coverage	20 km	20 km	60 km	10 km	20 km
Avg. bandwidth per unit	20 Mbit/s	60 Mbit/s	40 Mbit/s	20 Mbit/s	up to 10 Gbit/s

Even though GPON infrastructure is the most beneficial PON solution of today in terms of performance, matured recommendation from authorized society (i.e., ITU-T, FSAN and IEEE) and more revenue in long-run among other PONs, it still lacks behind of proper bandwidth utilization in terms of all possible applied scenarios for being TDM based. To support the fact, several types of next generation PON (viz. 10GEAPON, WDM-PON, XL-PON etc.) are still being standardized. Among them, the most competitive solution would be WDM-PON that uses WDM technology instead of TDM at the physical interface. It uses a single feeder fiber to take advantage of the same economics associated with traditional PONs; but logically, WDM-PON uses a point-to-point architecture. Therefore, it is far more scalable and secure than other PONs. Today, WDM-PON delivers 20 Gbit/s per fiber (1.25 Gbit/s dedicated per user on a 1:16 split). In addition, WDM-PON enables a dedicated wavelength for each user, ensuring the security that SMBs demand and providing greater provisioning flexibility – essentially, WDM-PON is a fat pipe that can support Ethernet, Metro Ethernet or TDM, depending on what the provider wants to offer. Within the next two years, WDM-PON will offer 80 Gbit/s per fiber probably, which will allow 2.5 Gbit/s per subscriber on a 32:1 split. Besides, WDM-PON is also less expensive to deploy, maintain and upgrade. For example, it uses colorless optics, which eliminates the sparing issue associated with typical DWDM network elements. In addition, if a bandwidth upgrade becomes available with better line terminals and network terminals, the provider can simply upgrade these without affecting service for existing cus-

tomers. Also, WDM-PON channel plan changes can be accommodated simply by swapping the arrayed wavelength grating (AWG) at the OLT and remote splitter, rather than having to pull new fiber or replace the terminals themselves. Considering functionality and scalability, it seems that WDM-PON seems like the obvious upgrade path for GPON but WDM-PON still facing some hurdles like the function of density. While this density mirrors GPON, the OLT must increase the feeder fiber count to increase the subscriber count from 16 today to 640 subscribers or more in the future [7]. Hereby, although WDM-PON is significantly (four to five times) less expensive per Mbit/s, it is currently about three to four times the cost of GPON on a per-subscriber basis.

4. GPON Features

4.1. Operating Wavelength

The operating wavelength range is about 1500 nm for the downstream and 1350 nm for the upstream. In addition a wavelength range 1550–1560 nm can be used for downstream RF video distribution.

4.2. Open Bandwidth Allocation

Both, static bandwidth allocation (SBA) as well as dynamic bandwidth allocation (DBA) can be implemented in GPON networks. SBA guarantees fixed bandwidth for each ONU whereas DBA guarantees the dynamic bandwidth allocation for each ONU in accordance to users' requests.

Basically, DBA is a process for consenting quick adoption of user-end bandwidth allocation based on current traffic need. Hereby, OLT controls the whole DBA process that allocates the bandwidth to ONUs. This process works only in upstream whereas downstream traffic is just been broadcasted.

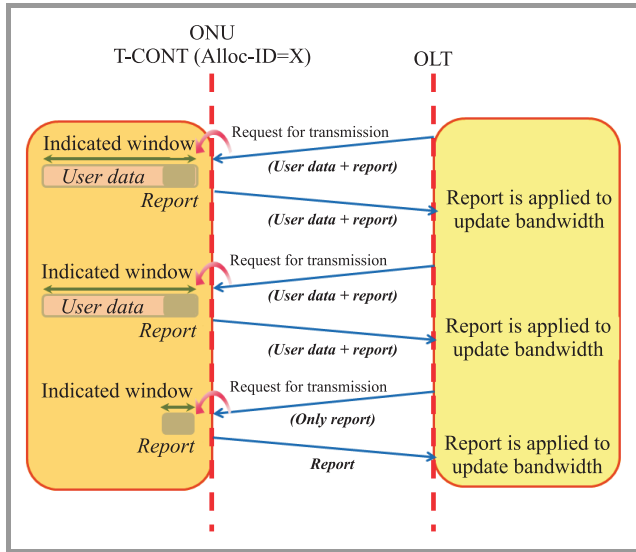

Fig. 2. DBA process.

Figure 2 shows a typical DBA process. To determine the quantity of traffic allocate to an ONU, the OLT needs to know the traffic status of the T-CONT associated with the ONU. In status reporting method, a T-CONT indicates the quantity of packets that are waiting in its buffer. Once the OLT receive this information, it can reapportion the grants to various ONUs accordingly. If an ONU has no information waiting to be transported, a grant is sent to an idle cell upstream upon receiving for indicating that the buffer is empty. Hence, this informs the OLT that the grant for that T-CONT can be assigned to other T-CONTs. Besides, if an ONU has a long queue waiting in the buffer, the OLT can assign multiple T-CONTs to that ONU [8].

4.3. Emence Downstream Efficiency

GPON can provide the downstream efficiency up to ~92% since non encoded non return to zero (NRZ) is applied [2]. The ~8% efficiency is mitigates by use of overhead. IP-based standard definition TV (SDTV, needs ~3 Mbit/s BW) and particularly high-definition TV (HDTV, needs ~18 Mbit/s BW) services are now the increasing demand of today’s customer.

It is seen that GPON can provide guarantee of high speed internet subscription for 278 users (Fig. 3) even if the video content goes 100% HDTV with 50 video channels on PON because of its efficient 2,488 Mbit/s downstream transport [9].

Likewise, for a single family unit network with multiple dwelling unit (MDU) application of splitting ratio of 1:32, GPON is capable for proving basic high speed internet ser-

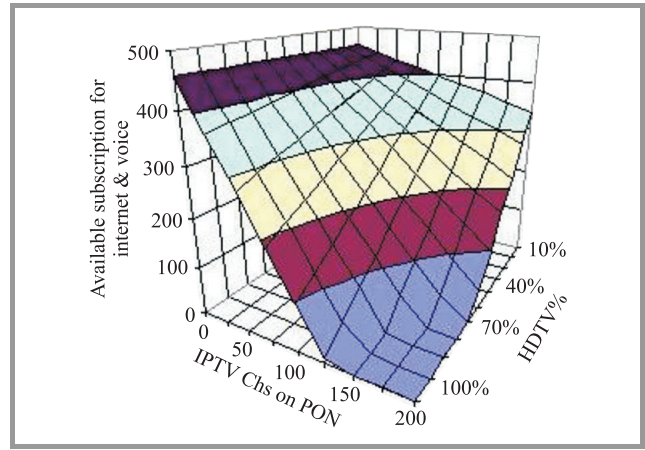

Fig. 3. Available flawless subscription for SDTV and HDTV application in GPON interface [9].

vice along VOIP/SDTV/HDTV services to 32 ONU supporting 8 subscriber each (viz. 278/32). Eventhough the number of this subscription can be even more depending upon technical and business practice of service provider.

4.4. Gauranted QoS at Upstream

Triple play services (Internet, voice and video) require a solid backbone of QoS mechanism where GPON is a right candidate as it is enhanced with PON layer mechanism that goes beyond layer 2 Ethernet and layer 3 IP class of service (CoS) to ensure the delivery of high quality voice, video and TDM data over TDMA based shared media. However, GPON upstream rate is ~1.25 Gbit/s that is 20% higher in comparison to EPON but its state of art QoS architecture makes different from other competing solutions existing today. GPON uses an out-of-band bandwidth allocation map with the concept of traffic containers (T-CONTs) that ensure upstream-granted entity. The downstream and upstream frame timing is 8 kHz at standard telecom where services are encapsulated into frames in their innate format by a process called GPON encapsulation mode (GEM). GPON also supports protection switching in less than 50 ms like SONET/SDH.

GPON is enhanced with unique low-latency capability is that all upstream TDMA bursts from all ONUs can occur within an 8 kHz frame (i.e., 125 μs) as illustrated in above figure (Fig. 4). Each downstream frame comprises of an efficient bandwidth allocation map that is broadcasted to all ONUs and supported a fine granularity of bandwidth allocation. This so called out-of-band mechanism aids the GPON DBA to sustenance very small grant cycles without conceding bandwidth utilization.

Basically, T-CONTs are a PON-layer mechanism for upstream QoS whereas CoS is determined by layer 2 or layer 3 methods that use the same T-CONT type. Here, voice services are assigned to a voice T-CONT at ONU and best-effort data are assigned to best-effort T-CONTs. DBA confirms that T-CONTs using a higher CoS, like voice, get priority access on the PON and preempt T-CONTs with lower CoS, such as Internet data. T-CONT size and timing

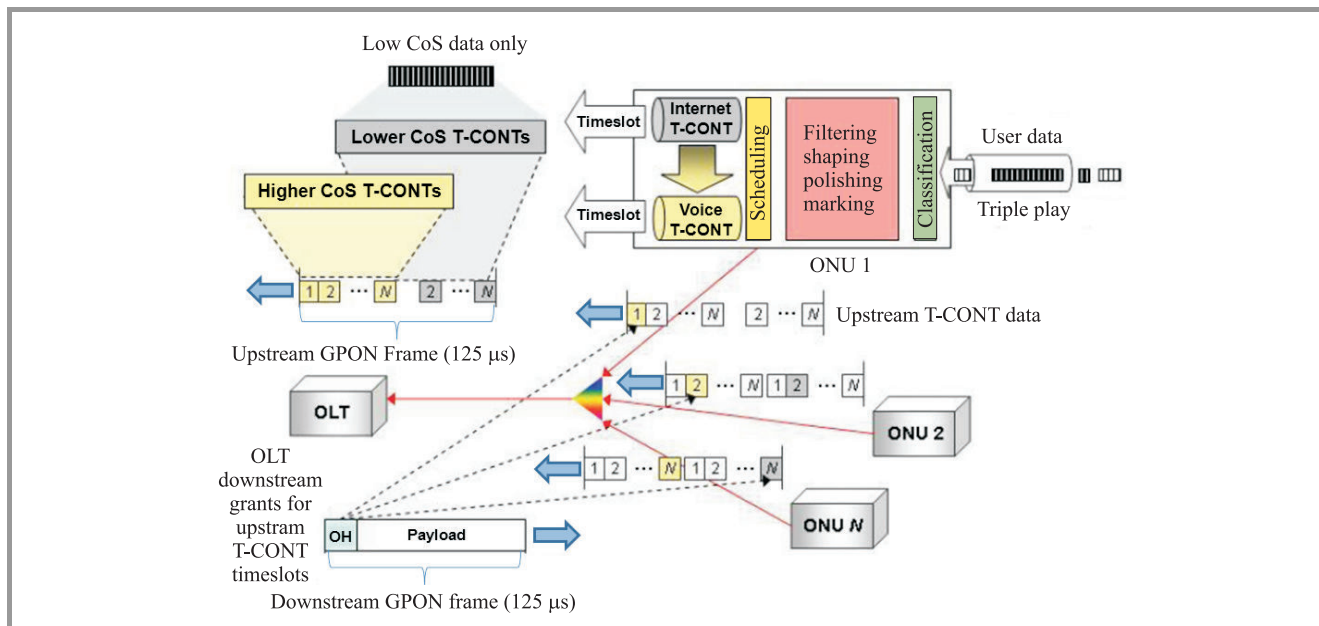

Fig. 4. GPON QoS/CoS capability that enriched with fragmented payloads.

are then allocated on the PON by the OLT based on the CoS demands and resources in PON [9].

However, GEM also aids the fragmented payloads so as a low-CoS T-CONT can stop its upstream burst in the middle of a payload, may allow a higher-CoS T-CONT its access and then resume its transmission when told to by the DBA mechanism. Therefore, large bursts of low-priority, best-effort data will have minimal effect on high-priority, delay-sensitive traffic (i.e., voice and TDM) in a highly utilized PON.

4.5. Security

In GPON, downstream data are broadcasted to all ONUs and every ONU has allocated time when data belongs to it, as like TDM. For this reason some malicious user can reprogram their own ONU and can capture all the downstream data belong to all ONUs connected to that OLT. In upstream, GPON uses point to point connection so that all traffic is secured from eavesdropping. Therefore, each of confidential upstream information (such as security key) can be sent in clear text.

Thus in GPON, transmission layer specification (G.948.3) describes the use of an information security mechanism to ensure that users are allowed to access only the data intended for them. The encryption algorithm to be used is the advanced encryption standard (AES). It accepts 128, 192 and 256 byte keys which makes encryption extremely difficult to compromise. A key can be changed periodically without disturbing the information flow to enhance security [8].

4.6. Boosted with Interoperability

GPON standard is closed developed monitor by FSN and ITU-T that clearly indicates its feasibility of wide conver-

gence. GPON is still capable for providing a constant satisfactory transmission performance by use of CoS T-CONT assignments in integration to TDM circuit emulation service (CES) as well as ATM technology.

5. Key Triple-play Service Solutions with GPON

5.1. Voice Solution

GPON VoIP access service solution shown in Fig. 5, household user side adopts ONU with built-in VOIP function; Data service is directly accessed to IP network via MA5680T OLT [10]. In order to ensure the quality of voice service, GPON system and upper layer IP network need to support IP QoS, to perform the scheduling with higher priority on VOIP voice message.

GPON system is able to meet QoS requirement of different services through the means such as service flow

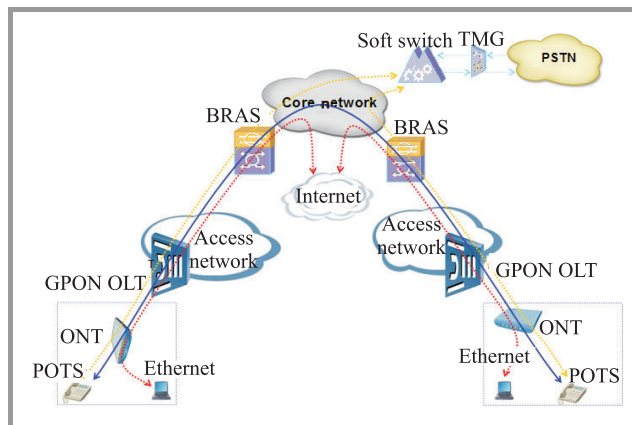

Fig. 5. GPON system VoIP solution.

classification, measurement, marking, and multi queuing mechanism, queue scheduling, buffer management, congestion handling, etc. GPON OLT performs the identification based on the user flow and bandwidth management in case of QoS handling of user flow entrance, to realize the management on the user at the network entrance, and classify the different services, by using one or multiple queuing scheduling methods to meet the requirements of QoS. The upper layer equipment marks the priority from the message of network downlink. In GPON OLT, the system can perform queuing scheduling and bandwidth management according to the marks.

5.2. Internet Access Solution

Two standard solutions can be adopted for implementing internet access solution over GPON. One of them could to wholesale the point to point protocol over Ethernet (PPPoE) subscribers to the ISPs, which is commonly known as virtual local area network (VLAN) stacking multi-ISP wholesale Internet access solution. This solution is more suitable for Internet service wholesale to large ISPs where each of them own BRAS. In the solution, the GPON platform performs the following functions:

- identifying different ISPs,
- performing traffic isolation between ISPs,
- identifying subscribers,
- performing traffic isolation between subscribers,
- implementing PPPoE access.

This method is suitable for Internet service wholesale to large ISPs.

Another one is to adopt layer 2 tunneling protocol (L2TP). In this solution, the carrier's broadband remote access server (BRAS) supports L2TP access concentrator (LAC), while each ISP provides the L2TP network server (LNS). L2TP tunnels are set up between the LAC and the LNS. Subscribers are accessed via PPPoE. This solution is more suitable for Internet service wholesale among small ISPs. In some scenarios like Internet service provisioning for business subscribers, Internet protocol over Ethernet (IPoE) dedicated line access is recommended and in this instance, GPON system guarantees the QoS. However, GPON may also establish VPNs with the upstream carrier's PE equipment.

5.2.1. VLAN Stacking Multi-ISP Wholesale Internet Access Solution

Hereby, GPON OLT adopts 802.1Q VLAN tagging for subscriber identification to enable multi-ISP wholesale access. The outer VLAN is used for ISP identification, and the inner VLAN is used for identification of subscribers that

are to be sent to the BRAS for authentication. PPPoE are adopted for subscriber access, as it is shown in Fig. 6.

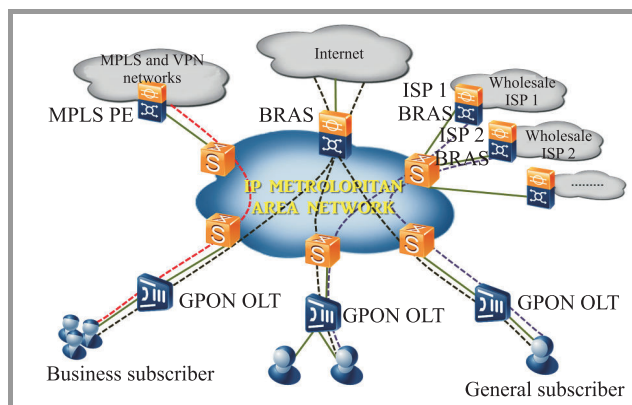

Fig. 6. Wholesale subscriber access via VLAN stacking.

According to Fig. 6, wholesale ISP subscribers do access internet via VLAN stacking. Each wholesale subscriber has two layers of VLAN tags. The outer VLAN tag is used for ISP identification. It is reported to the ISP BRAS after being transparently through the layer 2 metropolitan area network (MAN). The inner VLAN tag is used for identification of ISP wholesale subscribers. Each subscriber is identified via an inner VLAN tag. The ISP BRAS will first extract the outer VLAN tag and implement PPPoE authentication. After that, the ISP BRAS complete the authentication via binding between the inner VLAN and the subscriber account. When the number of ISP subscribers exceeds limit (i.e., 4000), another outer VLAN layer can be assigned to the ISPs, so each outer VLAN can supports access subscribers within limit.

GPON OLTs are capable to work in VLAN stacking mode and common mode. When a GPON OLT port is work in VLAN stacking mode, after having received untagged packets, the OLT will insert two layers of VLAN tags to the packets and then send them upstream. The outer VLAN tag is used for ISP identification, while the inner VLAN tag is used for subscriber identification. And in common mode, the two layers of VLAN tags is used in combination for subscriber identification. VLAN stacking mode and common mode can coexist on most vendors provided GPON OLTs, where packet switching and forwarding are implemented based on the outer VLAN tag.

5.2.2. L2TP Multi-ISP Wholesale Internet Access Solution

In this solution (Fig. 7), the Internet access subscribers on the GPON are connected to the carrier's BRAS via PPPoE. The BRAS serves as the LAC as defined in L2TP to set up L2TP tunnels with LNSs of various ISPs. The BRAS is able to identify subscribers of different ISPs based on the VLAN tag contained in the GPON subscriber packet, or based on the domain name contained in the subscriber

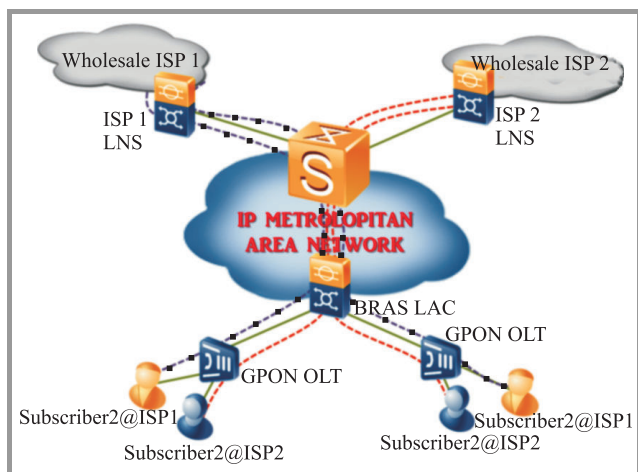

Fig. 7. Internet access L2TP using PPPoE.

account. It then accesses subscribers of different ISPs to the corresponding ISPs through different L2TP tunnels.

5.3. GPON IP Based Video Service Solution

The provisioning of GPON IP based video services is implemented by electronic program guide (EPG)/content portal. When an STB starts and passes authentication, it acquires an IP address. With the address, it accesses the video system to perform software load and user authentication. When it passes user authentication, the video management system will send an EPG according to his/her rights and service subscription. EPG is portal pages through which the subscriber can select services. There are many ways to acquire an EPG with assistance from the client on an STB and EPG/portal server. For BTV services, an EPG should offer necessary multicast session information such as multicast address, port no., media type, and coding scheme. Coding schemes for IPTV programs include the MPEG2, MPEG4, and WMV. The MPEG2 provides ordinary video quality at a code rate of 2 Mbit/s and broadcasting-class video quality at a rate of 3.5 Mbit/s~4 Mbit/s. The more advanced MPEG4/H.264 provides higher video compression ratios. The MPEG-4 enables high video quality at a rate of 1.5 Mbit/s while H.264 can provide more video services with higher definition at rates below 1 Mbit/s. Video streams are delivered using MPEG over IP [11]. Multicast video streams coming from the coder and video server are directly output to core network and then sent to subscribers via a FTTP access network.

IPTV that is already been emerged with many IP based broadband services, is continuously evolving and changing. At the same time, service providers' networks have different needs depending on markets, distribution areas, plant and density. Increasingly, service providers need access platforms to launch service from different points in the network, to utilize different copper or fiber facilities, and to incorporate more quality and performance with the services offered. Adaptability becomes an important aspect for access to meet a variety of needs, with the choice in

the hands of the service provider rather than dictated by the limitations of technology.

GPON optical network terminal (ONT) provides support for high speed data and high definition IPTV service with Gigabit Ethernet ports (see Fig. 1). It is a cost effective solution for point to multipoint scenarios where passive optical splitters are used to allow a single optical fiber for providing multiple premises. IPTV delivers video services based on IP multicast. At the source end, different program, sources are configured with different multicast address, and reach the ONU device through a series of broadcast service. Effective broadcast IPTV service requires extensive bandwidth and the support of IP multicast and IGMP. For deployments requiring open access or other multiple broadcast sources, these can be provisioned on VLAN basis. Thus, through IGMP and IP multicast, the ONT model provides full support for broadcast IPTV services with VLAN capability supporting open access IPTV solutions. The large bandwidth available on such GPON ONTs enables them to transparent transport all video encoding standards, including MPEG-2 and MPEG-4. In example, if each ONT supports over 256 multicast MPEG-2 video channels concurrently, then that is capable to provide virtually unlimited video streams support with unicast MPEG-2. Additionally, some ONTs (i.e., enablence ONTG4000i) are ideally suited to support VoD, PPV and other IPTV related packet-based services desired today by numerous network operators [12], [13].

6. Conclusion

In conclusion, GPON solution is expecting a robust, capable, reliable, cost-effective platform that yet been standardized by ITU-T and FSAN as well as being enhanced with ongoing research conducting at industry and academy. But it can be deployed today at access network architecture, so as to offer the end users more bandwidth to meet the demand of new services which will in turn generate more revenues and act as a baseline for the newer technologies to develop.

References

- [1] "Gigabit-Capable Passive Optical Networks (GPON): General Characteristics", ITU-T/G.984.1 [Online]. Available: http://www.itu.int/rec/dologin_pub.asp?lang=e&id=T-REC-G.984.1-200803-1!!PDF-E&type=items and http://www.itu.int/rec/dologin_pub.asp?lang=e&id=T-REC-G.984.1-200910-1!Amd1!PDF-E&type=items.
- [2] "Gigabit-capable Passive Optical Networks (GPON): Physical Media Dependent (PMD) layer specification", ITU-T/G.984.2, 2010 [Online]. Available: <http://www.itu.int/rec/>
- [3] "Gigabit-capable Passive Optical Networks (G-PON): Transmission convergence layer specification", ITU-T/G.984.3 [Online]. Available: http://www.itu.int/rec/dologin_pub.asp?lang=e&id=T-REC-G.984.3-200803-1!!PDF-E&type=items
- [4] B. Skubic, J. Chen, J. Ahmed, L. Wosinska, and B. Mukherjee, "A comparison of dynamic bandwidth allocation for EPON, GPON and next generation TDM PON", *IEEE Commun. Mag.*, vol. 47, issue 3, pp. 40–48, 2009.
- [5] ITU-T G.984.x [Online]. Available: <http://www.itu.int/rec/TREC-G/e>

[6] IEEE 802.3ah [Online]. Available: <http://www.ieee802.org/3/efm>

[7] C. Bock *et al.*, "Architecture of future access networks", in *Next-Generation FTTH Passive Optical Networks*, J. Prat, Ed. New York: Springer, 2008.

[8] I. Cale, A. Salihovic, and M. Ivekovic, "Gigabit passive optical network-GPON", *Inf. Technol. Interfaces*, pp. 679–684, June 2007.

[9] "GPON is more than just a faster PON", 2010 [Online]. Available: <http://www.broadlight.com/docs/pdfs/wp-gpon-more-than-faster-pon.pdf>

[10] "Solution – broader access bandwidth comes true", Huawei Technologies LTD., 2010 [Online]. Available: <http://www.huawei.com/publications/view.do?id=690&cid=342&pid=61>

[11] M. Abrams and A. Maislos, "Insights on delivering an IP triple play over GE-PON and GPON", in *Proc. Opt. Fiber Commun. Conf. OFC 2006*, Anaheim, USA, 2006.

[12] Enablece ONTG4000i, "Advanced Indoor GPON ONT for next generation Networks", 2010 [Online]. Available: http://www.enablece.com/media/pdf/951_00240_ont_g4000i_data_sheet_rev_1.0_17feb2010.pdf

[13] "Gigabit-capable passive optical networks (G-PON): ONT management and control interface specification", ITU-T G.984.4, 2010 [Online]. Available: http://www.itu.int/rec/dologin_pub.asp?lang=e&id=T-REC-G.984.4-200802-I!!PDF-E&type=items



D. M. S. Sultan received his B.Sc. in computer engineering from American International University Bangladesh in 2005. Soon he joined as a lecturer, CSE faculty in University of Development Alternative. In 2006, he has been awarded as PBX administrator in extend Broadband, Turkish Republic of

North Cyprus. Afterwards, he was an Assistant Product Engineer, Huawei Technologies (Bangladesh) Ltd in 2007. In 2010, he has achieved his M.Sc. in communication engineering major in electrical engineering – specialization research from Chalmers University of Technology, Sweden. Currently, he is working as Research Student at Photonics Laboratory, MC2.

e-mail: sultan@alumni.chalmers.se

Photonics Laboratory
MC2 Chalmers University of Technology
SE 41296, Gothenburg, Sweden



Md. Taslim Arefin received his B.Sc. in computer engineering from American International University Bangladesh in 2005. Afterwards, he joined University of Development Alternative as a Lecturer, CSE department. He pursued his M.Sc. in electrical engineering – specialization telecommunications from Blekinge Institute of Technology, Sweden in 2008. At latest, he is working as Senior Lecturer in the Dept. of ETE at Daffodil International University, Dhaka, Bangladesh.

e-mail: arefin@daffodilvarsity.edu.bd

Department of Electronics
and Telecommunication Engineering
Daffodil International University
Dhanmondi, Dhaka-1209, Bangladesh