

A. GLOWACZ*, A. GLOWACZ**, Z. GLOWACZ***

RECOGNITION OF MONOCHROME THERMAL IMAGES OF SYNCHRONOUS MOTOR WITH THE APPLICATION OF SKELETONIZATION AND CLASSIFIER BASED ON WORDS

ROZPOZNAWANIE MONOCHROMATYCZNYCH OBRAZÓW CIEPLNYCH SILNIKA SYNCHRONICZNEGO Z ZASTOSOWANIEM SZKIELETYZACJI I KLASYFIKATORA OPARTEGO NA SŁOWACH

Thermography is a technology that enables recognition of objects in the specific area. The goal of using thermographic techniques for ironworks is to diagnose electrical equipment. These techniques can be also use to increase safety and quality control in ironworks. Faulty equipment can be dangerous for engineers. Article describes the method of the recognition of imminent failure states of synchronous motor. Thermal images of the stator are used for an analysis of electrical machine. Researches of image processing techniques have been carried out for three states of motor. Proposed approach uses patterns recognition. Using of medial axis transformation and classifier based on words gave good results. In the future electrical machines and metallurgical equipment will use diagnostic systems based on recognition of thermal images.

Keywords: Electrical fault detection, Pattern analysis, Thermal images, Synchronous motor, classifier based on words

Termografia jest technologią, która umożliwia rozpoznawanie obiektów w określonym obszarze. Celem używania technik termograficznych dla hut jest diagnozowanie sprzętu elektrycznego. Te techniki mogą być również używane do zwiększenia bezpieczeństwa i jakości kontroli w hutach. Wadliwy sprzęt może być niebezpieczny dla inżynierów. Artykuł opisuje metodę diagnostyki stanów przedawaryjnych silnika synchronicznego. Obrazy cieplne stojana są używane do analizy maszyny elektrycznej. Badania technik przetwarzania obrazu zostały wykonane dla trzech stanów silnika. Proponowana metoda używa rozpoznawania wzorców. Użycie transformacji medialnej osi i klasyfikatora opartego na słowach dawało dobre wyniki. W przyszłości maszyny elektryczne i sprzęt hutniczy będą używać systemów diagnostycznych opartych na rozpoznawaniu obrazów cieplnych.

1. Introduction

Thermography is a technology that enables recognition of objects in the specific area. This technology is widely used in industry for over 50 years. Every day it is applied by industry to help solve their electrical and mechanical problems. Today the thermographic techniques have found many applications in community such as monitoring of police, firefighting, medical diagnostics, medical research. It is used by mountain rescue teams.

There are some of the industrial applications for thermography. Most of them regard recognition of structural insulation deficiencies and electrical components. Thermography is also used for diagnostics for leaks and heating cooling loss. Another application for thermography is border security, where most threats occur at night.

Thermal imaging is non-contact, non-destructive and non-intrusive. Measurements can be done at a distance [1-3].

The goal of using thermographic techniques for ironworks is to diagnose electrical equipment. These techniques can be also use to increase safety and quality control in ironworks. Faulty equipment can be dangerous for engineers. Thermography can detect very small differences in thermal signatures for example: deficiencies, component faults, energy spikes, heat loss, electrical issues and much more. Analysis of faults enables long term safety of equipment. Diagnostics of electrical machine includes analysis procedures and devices used to determine the state of a machine. Infrared thermography and methods of digital image processing can be used for fault diagnostics. Electrical machines are made of steel, copper and aluminum elements. Thermal, electrical and mechanical properties of materials were described in the literature [4-10].

Many faults of electrical machines are caused by loose connections [11-15]. Under such conditions, there is to current that can cause an increase in temperature. Next this temperature can cause motor to fail. This article describes the method

* AGH UNIVERSITY OF SCIENCE AND TECHNOLOGY, FACULTY OF ELECTRICAL ENGINEERING, AUTOMATICS, COMPUTER SCIENCE AND BIOMEDICAL ENGINEERING, DEPARTMENT OF AUTOMATICS AND BIOMEDICAL ENGINEERING, AL. A. MICKIEWICZA 30, 30-059 KRAKÓW, POLAND

** AGH UNIVERSITY OF SCIENCE AND TECHNOLOGY, FACULTY OF COMPUTER SCIENCE, ELECTRONICS AND TELECOMMUNICATIONS, DEPARTMENT OF TELECOMMUNICATIONS, AL. A. MICKIEWICZA 30, 30-059 KRAKÓW, POLAND

*** AGH UNIVERSITY OF SCIENCE AND TECHNOLOGY, FACULTY OF ELECTRICAL ENGINEERING, AUTOMATICS, COMPUTER SCIENCE AND BIOMEDICAL ENGINEERING, DEPARTMENT OF POWER ELECTRONICS AND ENERGY CONTROL SYSTEMS, AL. A. MICKIEWICZA 30, 30-059 KRAKÓW, POLAND

of diagnosis of a synchronous motor. This approach uses thermal images of the stator to analyze the state of machine.

2. Scheme of recognition of thermal images of synchronous motor

The proposed scheme of recognition of thermal image of synchronous motor contains two phases. The pattern creation process is the first of them (Fig. 1). The identification process is the second phase. These phases include steps used in image processing.

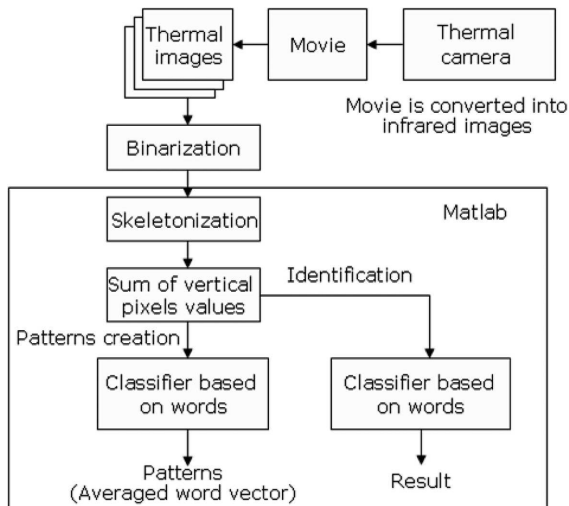

Fig. 1. Scheme of recognition of thermal image of synchronous motor with the use of skeletonization and classifier based on words

The pattern creation process starts with recording of movie. This recording is stored on a PC. After that it is converted into thermal images. Next binarization is used. After that image is processed by skeletonizing technique called *medial axis transformation*. In the next step sums of vertical pixels values are calculated. Each sample which is used in the pattern creation process gives us 640 sums of vertical pixels values. These sums of vertical pixels create feature vector. Next feature vectors are converted into the averaged word vector (in the pattern creation process) or the word vector (in the identification process). The word vectors (averaged word vectors) are created by classifier based on words. In the identification process these vectors are compared with each other.

2.1. Video recording

Thermal camera operates like a regular camcorder. It has the ability to detect heat energy. This measurement tool can measure thermal radiation in absolute darkness. It does not need any source of external light. Nowadays thermal camera systems have high resolution views and good image quality. It has also high image sensitivity. These systems contain complex image processing software.

Thermal camera used in analysis was set 0.25m above stator of synchronous motor. It created images at a resolution of PAL D-1 (640×460 pixels) in grayscale with a resolution of 8 bits (values 0-255). After that obtained video was stored on a PC as an AVI format (Audio Video Interleave).

2.2. Acquisition of thermal images

24 monochrome thermal images were obtained from 1 second of movie. A thermal image was extracted from the movie by a Perl program. System of image processing also used *mplayer* library. Obtained monochrome image had resolution of 640×480 pixels. The color scale was selected automatically by the camera depending on the background. Next, monochrome thermal images were processed by Matlab.

2.3. Binarization

Grayscale image was converted into binary image by the binarization method. The binarization process formed an object from pixels. These pixels were selected if their value was greater than threshold value. A binary image was obtained after the binarization process [16]. The threshold value was very essential parameter. This parameter was selected in the analysis of thermal images.

2.4. Skeletonization

A skeleton of an object could have been used to describe its structure. Developed skeletonizing technique was called *medial axis transformation*. An intuitive explanation of this technique was based on the *prairie fire analogy*. Figures could have been composed of dry grass on a bare dirt background.

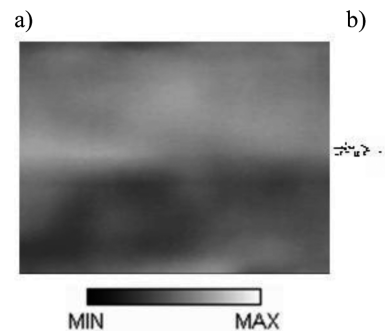

Fig. 2. a) Monochrome thermal image of stator of faultless synchronous motor, b) Monochrome thermal image of stator of faultless synchronous motor after binarization and skeletonization (in negative)

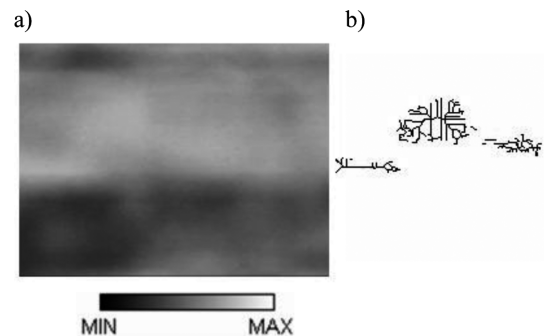

Fig. 3. a) Monochrome thermal image of stator of synchronous motor with partly shorted stator coil, b) Monochrome thermal image of stator of synchronous motor with partly shorted stator coil after binarization and skeletonization (in negative)

For example a fire were to be started simultaneously on the perimeter of the grass. Next it burnt toward the center of the regions until all the grass was consumed. In the case of circle, the fire burnt to the center point of the circle. It was called the *quench point* of the circle. In the case of rectangle, the fire burnt from each side. Obtained the quench points or quench lines of figure were called its *medial axis skeleton*. The medial axis skeleton consisted of the set of points. These points were equally distant from two nearest points of an object boundary [17]. Monochrome thermal images of stator of synchronous motor were presented in Figures 2-4.

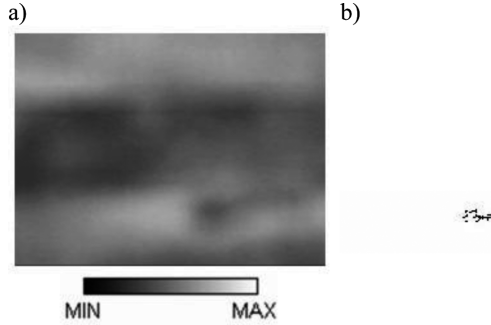

Fig. 4. a) Monochrome thermal image of stator of synchronous motor with one broken stator coil b) Monochrome thermal image of stator of synchronous motor with one broken stator coil after binarization and skeletonization (in negative)

2.5. Selection of features

Thermal image contained 640×480 pixels. Each pixel had a value from range $[0-1]$ (0 – black pixel, 1 – white pixel). Features of thermal image were the sums of vertical pixels values. Therefore, the feature vector contained 640 features (Fig. 5-7).

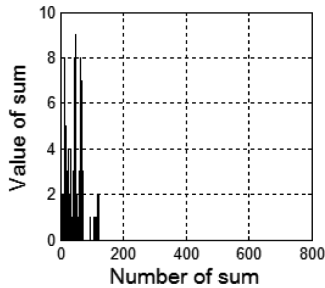

Fig. 5. Sums of vertical pixels values for thermal image of faultless synchronous motor

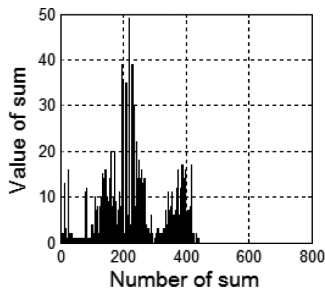

Fig. 6. Sums of vertical pixels values for thermal image of synchronous motor with partly shorted stator coil

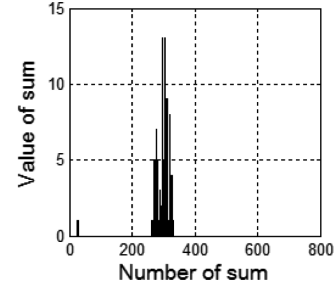

Fig. 7. Sums of vertical pixels values for thermal image of synchronous motor with one broken stator coil

These sums of vertical pixels were used in the classification step.

2.6. Classifier based on words

Many methods of processing and classification were described in the literature [18-43]. Many of them can be used in image processing. Classifier based on words was used to recognize acoustic signal. In this paper it was used to recognize thermal images. Proposed classifier used word vectors to identify the kind of fault. A pattern was a vector of features $\mathbf{x} = [x_1, x_2, \dots, x_n]$. Classes of patterns were denoted as w_1, w_2, \dots, w_M , where M was the index of the class. Training set was used in the pattern creation process. Training samples were processed into averaged feature vectors $\mathbf{m}_1, \mathbf{m}_2, \dots, \mathbf{m}_j$ (1),

$$\mathbf{m}_j = \frac{1}{P_j} \sum_{i=1}^{P_j} \mathbf{x}_i, \quad (1)$$

where $\mathbf{x}_i \in w_j$, P_j was the number of patterns from class w_j .

The averaged feature vector \mathbf{m}_j was processed into the averaged word vector \mathbf{v}_j . The averaged word vector was denoted as: $\mathbf{v}_j = [v_1, v_2, \dots, v_n]$, where v_1, v_2, \dots, v_n were coordinates (words). The averaged word vector corresponded to the class of pattern (w_1, w_2, \dots, w_M). Each coordinate m_i of the averaged feature vector \mathbf{m}_j was processed into coordinate of the averaged word vector \mathbf{v}_j . This word represented a range of values,

$$\left\{ \begin{array}{l} m_i \in [k, 2k) \Rightarrow m_i \rightarrow v_{i1} \\ m_i \in [2k, 3k) \Rightarrow m_i \rightarrow v_{i2} \\ \dots \\ m_i \in [kg, kg+k) \Rightarrow m_i \rightarrow v_{ig} \end{array} \right., \quad (2)$$

where $v_{i1} \dots v_{ig}$ denoted words, g was the number of words, m_i was coordinate of the averaged feature vector, k was rational number.

Proposed classifier used selected ranges of values. These ranges contained the values of coordinates of the averaged feature vectors. Classifier based on words used a limited number of words $v_{i1}, v_{i2}, \dots, v_{ig}$. The number of words was 260, because it was sufficient for recognition. After that the parameter k was chosen so as to obtain high accuracy.

Test set was used in the identification process. In this process a new image was processed into the new feature vector \mathbf{y} . This vector \mathbf{y} was processed into the word vector \mathbf{f} . This

vector \mathbf{f} was denoted as $\mathbf{f} = [f_1, f_2, \dots, f_n]$, where f_1, f_2, \dots, f_n were coordinates of the word vector,

$$\begin{cases} y_i \in [k, 2k) \Rightarrow y_i \rightarrow v_{i1} \\ y_i \in [2k, 3k) \Rightarrow y_i \rightarrow v_{i2} \\ \dots \\ y_i \in [kg, kg+k) \Rightarrow y_i \rightarrow v_{ig} \end{cases}, \quad (3)$$

where $v_{i1} \dots v_{ig}$ denoted words, g was the number of words, y_i was coordinate of the new feature vector, k was rational number.

Analyzed sample was assigned to the class whose averaged word vector was the closest to the new word vector \mathbf{f} . To achieve this goal proposed classifier used lexicographical comparison. This comparison used two strings containing coordinates of the averaged word vector and coordinates of the new word vector. It was defined as follows: $f_1 = v_1; f_2 = v_2; \dots; f_n = v_n$. The result of comparison was binary (*false* or *true*). These results were used in following formulas:

$$U_j = \frac{U_1}{U_2} \cdot 100\%, \quad (4)$$

$$\max(U_j) \Rightarrow \mathbf{f} \rightarrow w_j \quad j = 1, 2, \dots, M, \quad (5)$$

where U_j was the percentage number of well-recognized words, U_1 was the number of correctly compared words, U_2 was the number of all comparisons, \mathbf{f} was the word vector.

The biggest influence on image recognition results had the data contained in the feature vector and parameter k . Different parameter k was used in the researches.

3. Results of thermal image recognition of synchronous motor

Researches of image processing techniques have been carried out for three states of motor. Classes of patterns were denoted: synchronous motor, synchronous motor with partly shorted stator coil (Fig. 8), synchronous motor with one broken stator coil.

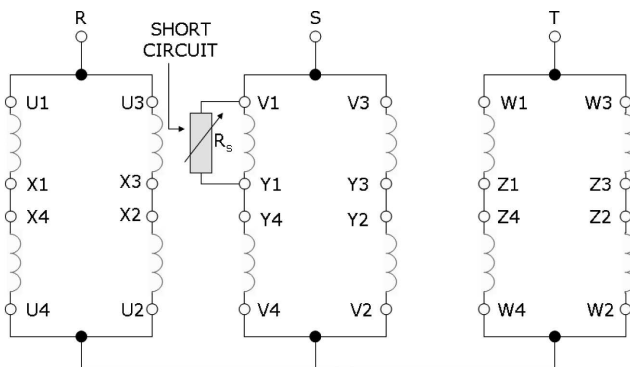

Fig. 8. Scheme of stator winding for the synchronous motor with partly shorted stator coils (V1-Y1)

Electric machine had following supply conditions: faultless synchronous motor $U = 250$ V, $I = 37.5$ A, synchronous motor with partly shorted stator coil $U = 250$ V, $I = 83.5$ A, 0.85Ω resistance, synchronous motor with one broken stator coil $U = 250$ V, $I = 82$ A;

where: I – current of one motor phase, U – supply voltage.

Synchronous motor operated with open-loop control. Three movies were recorded. After that these movies were converted into images. Training set contained 30 monochrome thermal images. Test set contained 132 monochrome thermal images. Efficiency of thermal image recognition was defined as:

$$ET = \frac{K_1}{K}, \quad (6)$$

where: ET – efficiency of thermal image recognition, K_1 – number of correctly identified test samples, K – number of all test samples.

Efficiency of thermal image recognition of synchronous motor was presented (Fig. 9).

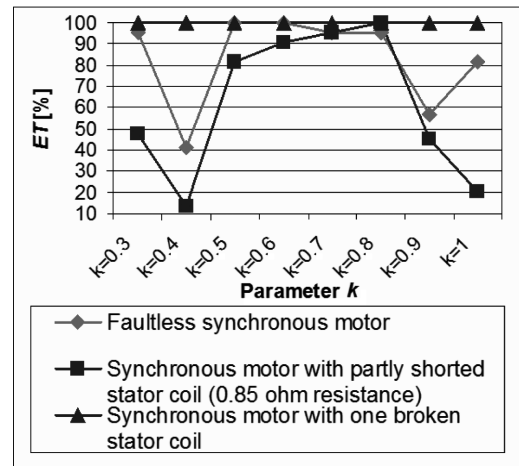

Fig. 9. Thermal image recognition efficiency of synchronous motor depending on parameter k

The best results were obtained for $k = 0.8$. Efficiency of thermal image recognition of synchronous motor was in the range of 95.45-100%.

4. Conclusion

This article presented the method of diagnosis of a synchronous motor. This approach was based on recognition of thermal images of the stator. Researches of image processing techniques have been carried out for synchronous motor. Medial axis transformation and classifier based on words gave good results. Proposed approach used patterns recognition. The next step of researches will be expanding the number of failures of motors. In the future electrical machines and metallurgical equipment will use diagnostic systems based on recognition of thermal images.

Acknowledgements

The research has been partly supported by the AGH University of Science and Technology, under contract no. 11.11.120.612 (Adam Głowacz).

The work of Andrzej Głowacz has been supported by the AGH University of Science and Technology under contract no. 11.11.230.018.

The research has been partly supported by the AGH University of Science and Technology, under contract no. 11.11.120.354 (Zygfryd Głowacz).

REFERENCES

- [1] M. Seboek, M. Gutten, M. Kucera, Diagnostics of electric equipments by means of thermovision, *Przeglad Elektrotechniczny* **87**, 10, 313-317 (2011).
- [2] A. Glowacz, A. Glowacz, Z. Glowacz, Diagnostics of Direct Current generator based on analysis of monochrome infrared images with the application of cross-sectional image and nearest neighbor classifier with Euclidean distance, *Przeglad Elektrotechniczny* **88**, 6, 154-157 (2012).
- [3] A. Glowacz, A. Glowacz, P. Korohoda, Recognition of Color Thermograms of Synchronous Motor with the Application of Image Cross-Section and Linear Perceptron Classifier, *Przeglad Elektrotechniczny* **88**, 10A, 87-89 (2012).
- [4] O.A. Kogtenkova, S.G. Protasova, A.A. Mazilkin, B.B. Straumal, P. Zieba, T. Czepe, B. Baretzky, Heat effect of grain boundary wetting in Al-Mg alloys, *Journal of Materials Science* **47**, 24, 8367-8371 (2012).
- [5] D. Gogola, A. Krafcik, O. Strbak, I. Frollo, Magnetic Resonance Imaging of Surgical Implants Made from Weak Magnetic Materials, *Measurement Science Review* **13**, 4, 165-168 (2013).
- [6] G. Krolczyk, S. Legutko, A. Stoic, Influence of cutting parameters and conditions onto surface hardness of Duplex Stainless Steel after turning process. *Tehnicki Vjesnik-Technical Gazette* **20**, 6, 1077-1080 (2013).
- [7] K. Nadolny, W. Kaplonek, Analysis of Flatness Deviations for Austenitic Stainless Steel Workpieces after Efficient Surface Machining, *Measurement Science Review* **14**, 4, 204-212 (2014).
- [8] T. Smolnicki, M. Stanco, D. Pietrusiak, Distribution of loads in the large size bearing – problems of identification, *Tehnicki Vjesnik-Technical Gazette* **20**, 5, 831-836 (2013).
- [9] J.M. Koscielny, M. Syfert, Application properties of methods for fault detection and isolation in the diagnosis of complex large-scale processes. *Bulletin of the Polish Academy of Sciences-Technical Sciences* **62**, 3, 571-582 (2014).
- [10] J.B. Krolczyk, An attempt to predict quality changes in a ten-component granular system, *Tehnicki Vjesnik-Technical Gazette* **21**, 2, 255-261 (2014).
- [11] P. Idziak, S. Rawicki, Analysis of stator deformations of a three-phase squirrel-cage induction motor. *Przeglad Elektrotechniczny* **86**, 4, 184-187 (2010).
- [12] L. Golebiowski, M. Golebiowski, D. Mazur, Unscented kalman filter in rotor diagnostic testing of the asynchronous motor. *Przeglad Elektrotechniczny* **87**, 8, 48-52 (2011).
- [13] Z. Szymanski, Application of the Magnetic Field Distribution in Diagnostic Method of Special Construction Wheel Traction Motors. *Advanced Computer Techniques in Applied Electromagnetics, Book Series: Studies in Applied Electromagnetics and Mechanics* **30**, 449-456 (2008).
- [14] A. Glowacz, W. Glowacz, Sound recognition of dc machine with-application of FFT and backpropagation neural network, *Przeglad Elektrotechniczny* **84**, 9, 159-162 (2008).
- [15] D. Valis, L. Zak, O. Pokora, Engine residual technical life estimation based on tribo data, *Eksploracja i Niezawodnosc-Maintenance and Reliability* **16**, 2, 203-210 (2014).
- [16] L.G. Shapiro, G.C. Stockman, *Computer Vision 2002*, Prentice Hall.
- [17] W.K. Pratt, *Digital Image Processing*, A John Wiley & Sons, Inc., Publication, Los Altos, California, 2007.
- [18] S. Kluska-Nawarecka, D. Wilk-Kolodziejczyk, K. Regulski, G. Dobrowolski, Rough Sets Applied to the RoughCast System for Steel Castings, *Intelligent Information and Database Systems, ACIIDS, Lecture Notes in Artificial Intelligence* **6592**, 52-61 (2011).
- [19] W. Orlewski, A. Siwek, Hydroelectric power plant using dump industrial water, *Rynek Energii*, 6, 87-91 (2010).
- [20] J. Jaworek, P. Augustyniak, A cardiac telerehabilitation application for mobile devices, *IEEE Conference on Computing in Cardiology*, Hangzhou, China, 241-244 (2011).
- [21] E. Kantoch, M. Smolen, P. Augustyniak, P. Kowalski, Wireless Body Area Network System based on ECG and Accelerometer Pattern, *IEEE Conference on Computing in Cardiology*, Hangzhou, China, 245-248 (2011).
- [22] D. Mazurkiewicz, Computer-aided maintenance and reliability management systems for conveyor belts, *Eksploracja i Niezawodnosc-Maintenance and Reliability* **16**, 3, 377-382 (2014).
- [23] D. Pleban, Definition and Measure of the Sound Quality of the Machine, *Archives of Acoustics* **39**, 1, 17-23 (2014).
- [24] W. Batko, B. Przystucha, Statistical Analysis of the Equivalent Noise Level, *Archives of Acoustics* **39**, 2, 195-198 (2014).
- [25] P. Augustyniak, M. Smolen, Z. Mikrut, E. Kantoch, Seamless Tracing of Human Behavior Using Complementary Wearable and House-Embedded Sensors, *Sensors* **14**, 5, 7831-7856 (2014).
- [26] D. Dabrowski, E. Jamro, W. Cioch, Hardware Implementation of Artificial Neural Networks for Vibroacoustic Signals Classification, *Acta Physica Polonica A* **118**, 1, 41-44 (2010).
- [27] D. Valis, K. Pietrucha-Urbanik, Utilization of diffusion processes and fuzzy logic for vulnerability assessment, *Eksploracja i Niezawodnosc-Maintenance and Reliability* **16**, 1, 48-55 (2014).
- [28] E.B. Skrodzka, B.B.J. Linde, A. Krupa, Effect of Bass Bar Tension on Modal Parameters of a Violin's Top Plate, *Archives of Acoustics* **39**, 1, 145-149 (2014).
- [29] E. Dudek-Dyduch, R. Tadeusiewicz, A. Horzyk, Neural network adaptation process effectiveness dependent of constant training data availability, *Neurocomputing* **72**, 13-15, 3138-3149 (2009).
- [30] A. Glowacz, W. Glowacz, Z. Glowacz, Recognition of armature current of DC generator depending on rotor speed using FFT, MSAF-1 and LDA, *Eksploracja i Niezawodnosc-Maintenance and Reliability* **17**, 1, 64-69 (2015).
- [31] N. Zuber, R. Bajric, R. Sostakov, Gearbox faults identification using vibration signal analysis and artificial intelligence methods, *Eksploracja i Niezawodnosc-Maintenance and Reliability* **16**, 1, 61-65 (2014).
- [32] A. Glowacz, Diagnostics of Synchronous Motor Based on Analysis of Acoustic Signals with the use of Line Spectral Frequencies and K-nearest Neighbor Classifier, *Archives of Acoustics* **39**, 2, 189-194 (2014).
- [33] M. Ziolkowski, J. Galka, B. Ziolkowski, T. Drwiega, Perceptual Wavelet Decomposition for Speech Segmentation, 11th Annual Conference of the International Speech Communication Association (INTERSPEECH 2010) **3-4**, 2234-2237 (2010).
- [34] Q. Wang, X. Yan, K.Y. Qin, Parameter Estimation Algorithm for the Exponential Signal by the Enhanced DFT Approach, *Measurement Science Review* **14**, 3, 126-135 (2014).
- [35] A. Glowacz, W. Glowacz, Dc machine diagnostics based on sound recognition with application of FFT and fuzzy logic, *Przeglad Elektrotechniczny* **84**, 12, 43-46 (2008).
- [36] K. Czopek, Cardiac Activity Based on Acoustic Signal Properties. *Acta physica polonica A* **121**, 1A, A42-A45 (2012).
- [37] M. Gorgon, P. Pawlik, M. Jablonski, J. Przybylo, Pixel Streams-based implementation of videodetector, 15th Annual IEEE Symposium on Field-Programmable Custom Computing Machines, Napa, April 23-25 2007, 321-322 (2007).

- [38] M.R. Ogiela, R. Tadeusiewicz, M. Trzupiek, Graph-based semantic description in medical knowledge representation and 3D coronary vessels recognition, *Ubiquitous Intelligence and Computing, Proceedings, Book Series: Lecture notes in computer science* **4611**, 1079-1088 (2007).
- [39] T. Hachaj, M.R. Ogiela, Application of neural networks in detection of abnormal brain perfusion regions, *Neurocomputing* **122** (Special Issue), 33-42 (2013).
- [40] A. Glowacz, Diagnostics of DC and Induction Motors Based on the Analysis of Acoustic Signals, *Measurement Science Review* **14**, 5, 257-262 (2014).
- [41] Z.F. Khan, A. Kannan, Intelligent Segmentation of Medical Images using Fuzzy Bitplane Thresholding, *Measurement Science Review* **14**, 2, 94-101 (2014).
- [42] M. Zajdel, B. Filipowicz, Exit selection process during crowd evacuation, modelled on the cockroach emergent behaviour, *Bulletin of the Polish Academy of Sciences-Technical Sciences* **62**, 3, 557-563 (2014).
- [43] G. Krolczyk, P. Raos, S. Legutko, Experimental analysis of surface roughness and surface texture of machined and fused deposition modelled parts, *Tehnicki Vjesnik- Technical Gazette* **21**, 1, 217-221 (2014).

Received: 20 February 2014.